



# TEST REPORT

## Maintenance testing of generic cabling products: Unscreened channel, Class E, 4 connector model

---

Performed for Excel

Report no.: 12225672-02

DANAK-19/22847

Page 1 of 55

1 appendix



**GTS**

ADVANCED  
TECHNOLOGY GROUP

**FORCE Technology**  
Venlighedsvej 4  
2970 Hørsholm  
Tel.+45 43 25 14 00

FORCE Technology Norway AS  
Nye Vakås vei 32  
1395 Hvalstad, Norway  
+47 64 00 35 00  
+47 64 00 35 01  
info@forcetechnology.no

FORCE Technology Sweden AB  
Tallmätargatan 7  
72134 Västerås, Sweden  
+46 (0)21-490 3000  
+46 (0)21-490 3001  
info@forcetechnology.se

FORCE Technology  
Park Allé 345  
2605 Brøndby, Denmark  
+45 43 25 00 00  
+45 43 25 00 10  
info@forcetechnology.dk  
www.forcetechnology.com



## OVERVIEW

<b>Title</b>	Maintenance testing of generic cabling products
<b>Product description</b>	Unscreened channel, Class E, 4 connector model
<b>Product identification</b>	See clause 2
<b>EC Cabling product ID</b>	5694
<b>Compliance statement</b>	2022-493
<b>Accreditation no.</b>	DANAK-19/22847
<b>Project no.</b>	12225672-02
<b>Original accreditation no.</b>	DANAK-19/13592
<b>Original project no.</b>	T207291
<b>Test object received</b>	26 July 2022
<b>Test period</b>	July 2022
<b>Client</b>	Excel Excel House Junction Six Industrial Park Electric Avenue Birmingham, B6 7JJ United Kingdom
<b>Contact</b>	Neil Payne
<b>Specification</b>	ISO/IEC 11801-1
<b>Results</b>	Compliance with specifications is verified
<b>Prepared by</b>	Lars Bjerring
<b>Reviewed by</b>	Lars Lindskov Pedersen
<b>Date</b>	4 August 2022
<b>Responsible</b>	

---

Lars Lindskov Pedersen, Test Manager  
FORCE LAN Components and Systems Testing



## Disclaimer

This report is issued under the rules of DANAK (Danish Accreditation) and ILAC (International Laboratory Accreditation Cooperation) including its MRA (Mutual Recognition Arrangement). Further information can be found at [www.danak.dk](http://www.danak.dk) and [www.ilac.org](http://www.ilac.org).

The report must not be reproduced, except in full, without the written approval of FORCE Technology.

The test results only relate to the items tested.

The original version of the report is archived in FORCE Technology's database and is sent in electronic duplicate to the customer. The stored version of the report at FORCE Technology prevails as documentation for its contents and validity.



# TABLE OF CONTENTS

<b>1</b>	<b>Summary .....</b>	<b>5</b>
<b>2</b>	<b>Channel components.....</b>	<b>6</b>
<b>3</b>	<b>Conclusion .....</b>	<b>8</b>
<b>4</b>	<b>Test results .....</b>	<b>9</b>
4.1	Cabling under test.....	9
4.2	Cable marking .....	9
4.3	High frequency transmission test results. Channel #1 (85 m horizontal cable) .....	10
4.4	High frequency transmission test results. Channel #2 (15 m horizontal cable) .....	28
4.5	Resistance properties .....	46
<b>5</b>	<b>Reference to applicable standards and documents .....</b>	<b>47</b>
5.1	Generic cabling standards .....	47
5.2	Special requirements for EC VERIFIED .....	47
<b>6</b>	<b>Test procedures.....</b>	<b>48</b>
6.1	Electrical test.....	48
6.1.1	Attenuation (Att).....	49
6.1.2	Return loss (RL).....	50
6.1.3	Near end crosstalk (NEXT).....	51
6.1.4	Powersum near end crosstalk (PSNEXT).....	51
6.1.5	Attenuation to crosstalk loss ratio (ACR-N) .....	52
6.1.6	Power sum ACR (PSACR-N).....	52
6.1.7	Attenuation to crosstalk ratio-far end (ACR-F).....	52
6.1.8	Power sum attenuation to crosstalk ratio far end (PSACR-F) .....	52
6.1.9	Unbalance attenuation, near end (Transverse conversion loss, TCL) .....	53
6.1.10	DC loop resistance .....	53
6.1.11	Propagation delay .....	53
6.1.12	Delay skew.....	53
	<b>Appendix 1 Test software .....</b>	<b>55</b>



## 1 Summary

A communication channel has been tested for compliance with generic cabling standards.

The purpose of the testing was to maintain certification of the channel according to the EC VERIFIED programme.

The channel for this electrical performance test was assembled and delivered to FORCE by the client.

The channel testing has been performed under laboratory conditions at the EC Cabling Group of FORCE.

This report firstly gives a detailed description of the channels under test. Then the conclusion is given followed by the test results. At last, an overview of the test procedures and applied standards are given.

## 2 Channel components

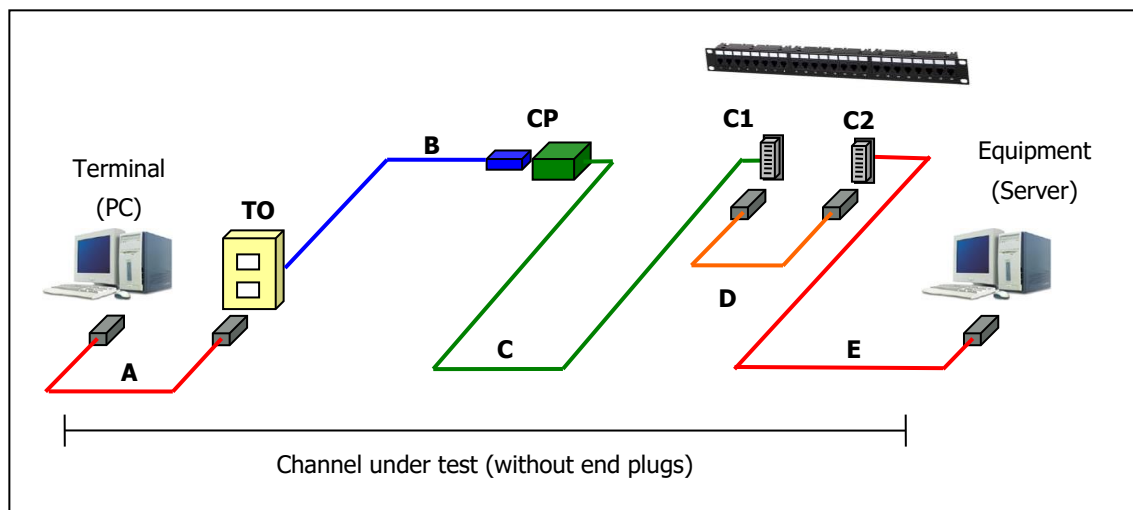

Figure 1. Channel definition (4 connector model).

The channel consists of the following components:

Item	Name	Cable type	Length	Connecting hardware
A	Terminal cord	Flexible cable	5 m	1 plug
B	Consolidation point cord	Solid cable	5 m	1 socket 1 plug
C	Horizontal cable	Horizontal cable	Channel #1: 85 m Channel #2: 15 m	2 sockets
D	Patch cord	Flexible cable	2 m	2 plugs
E	Equipment cord	Solid cable	3 m	1 socket
TO	Telecommunications Outlet / Wall Outlet			
CP	Consolidation Point connector (Sockets)			
C1,C2	Horizontal cross-connector / Floor Distributor / Patch panel			



### **Test samples**

#### **Horizontal cable:**

100-071 Excel Category 6 unshielded (U/UTP) cable LS0H (EC VERIFIED)

#### **RJ45 connector for telecommunications outlet, consolidation point, and patch panel:**

100-011 Excel Category 6 unshielded UTP Keystone Jack

#### **Terminal cord:**

100-314 Excel Category 6 unshielded UTP patch lead LS0H, booted (5 m) (EC VERIFIED)

#### **Patch cord:**

100-311 Excel Category 6 unshielded UTP patch lead LS0H, booted (2 m) (EC VERIFIED)

#### **Consolidation point cord:**

100-367 Excel Category 6 solid core unshielded UTP patch lead LS0H booted (5 m), terminated with jack 100-011

#### **Equipment cord:**

100-367 Excel Category 6 solid core unshielded UTP patch lead LS0H, booted (2 m), terminated with jack 100-011



### **3 Conclusion**

The tested sample complies with the applied requirements.

The test results are only applicable for the tested sample.



## 4 Test results

### 4.1 Cabling under test



Figure 2. Photo of product under test

### 4.2 Cable marking

Table 1. Cable marking, horizontal cable and solid cord cable

Characteristic	Result
Type of printing	Jet ink
Colour of text	Black text on a purple jacket
Text	002 M EXCEL 100-071 4PR 23AWG UTP LSOH --- LAN CABLE CAT6 BATCH NO 20190322001 EN50575 Class Dca DOP-EXL214 WWW.EXCEL-NETWORKING.COM

Table 2. Cable marking, flexible cord cable

Characteristic	Result
Type of printing	Jet ink
Colour of text	White text on a grey jacket
Text	excel CAT.6 UTP PATCH CABLE ETL VERIFIED TO TIA/EIA-568-B2-1 CAT.6 LSZH 20220331

### 4.3 High frequency transmission test results. Channel #1 (85 m horizontal cable)

**NEAR END CROSSTALK (NEXT).** From terminal end

Channel #1. Worst case margin: 3.2 dB at 238.2 MHz for Blue /Green pair.

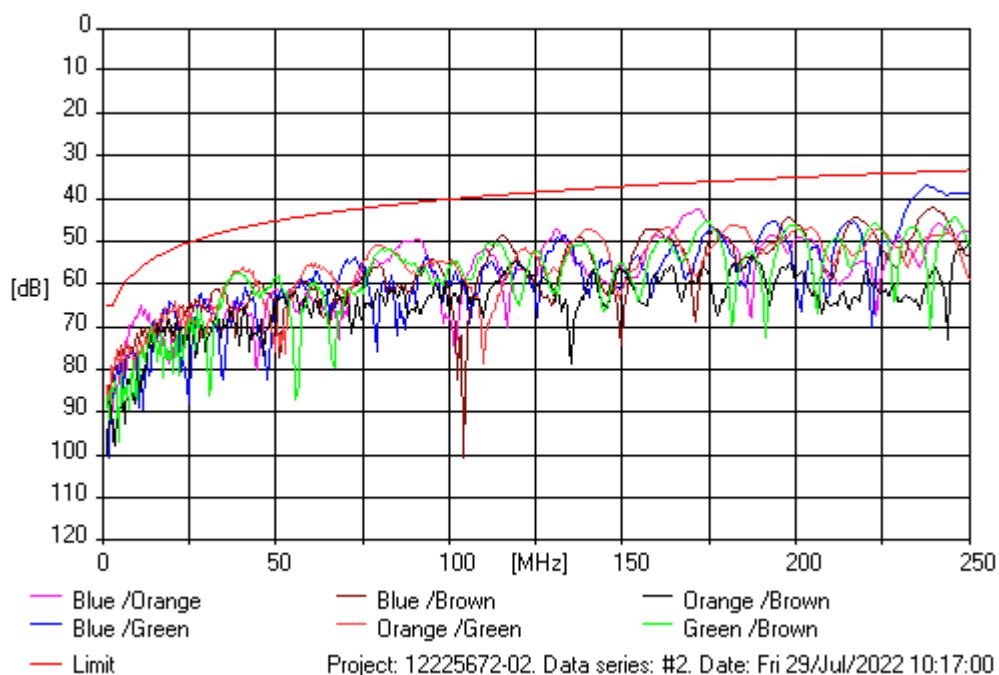

Table 3. Worst case margins at selected nominal frequencies.

Nominal Freq. [MHz]	Meas. Freq. [MHz]	Meas. value [dB]	Limit value [dB]	Calc. margin [dB]
1	1.0	83.5	65.0	18.5
4	4.1	75.0	62.8	12.2
16	15.9	69.0	53.3	15.8
100	100.0	54.5	39.9	14.6
250	250.0	38.9	33.1	5.8

**PS NEAR END CROSSTALK(PSNEXT).** From terminal end  
 Channel #1. Worst case margin: 5 dB at 238.2 MHz for Blue pair.

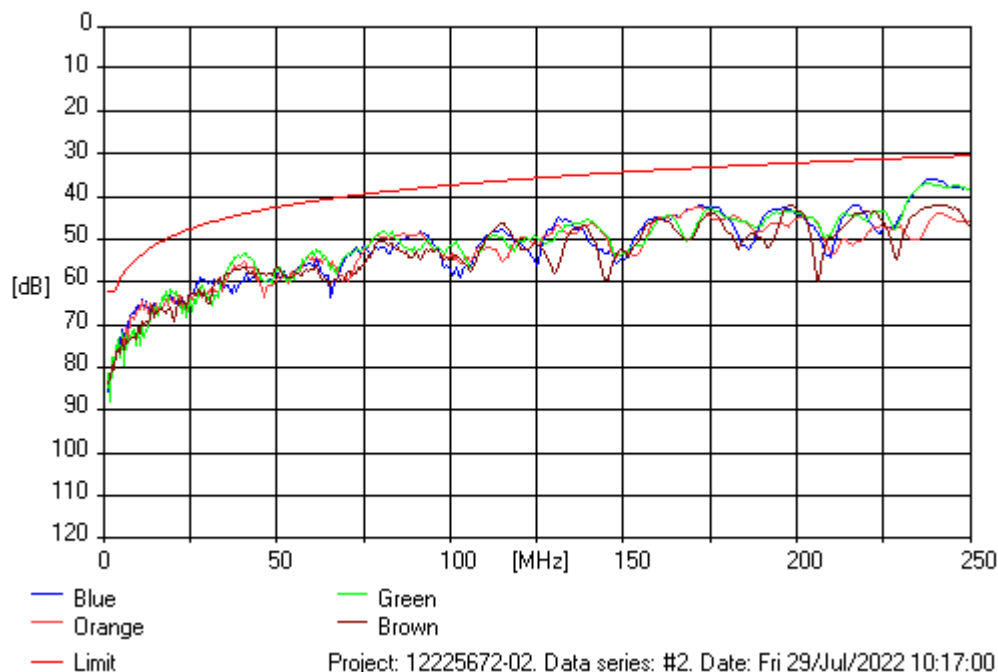

Table 4. Worst case margins at selected nominal frequencies.

Nominal Freq. [MHz]	Meas. Freq. [MHz]	Meas. value [dB]	Limit value [dB]	Calc. margin [dB]
1	1.0	81.3	62.0	19.3
4	4.1	73.3	60.3	13.0
16	15.9	66.1	50.6	15.5
100	100.0	51.2	37.1	14.1
250	250.0	38.2	30.2	8.1

**RETURN LOSS.** From terminal end

Channel #1. Worst case margin: 4.6 dB at 9.7 MHz for Orange pair.

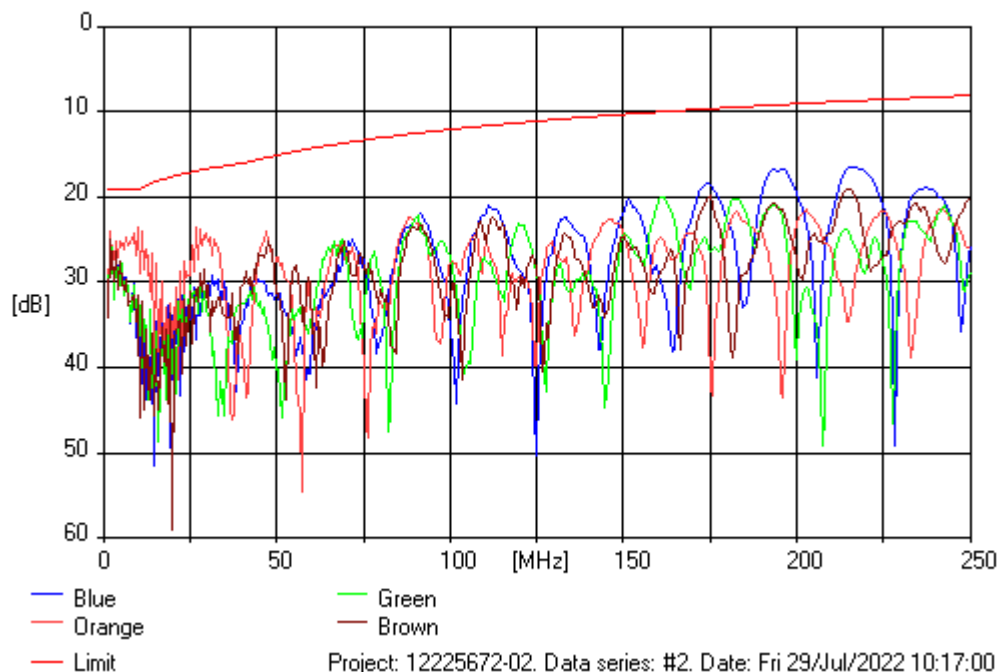

Table 5. Worst case margins at selected nominal frequencies.

Nominal Freq. [MHz]	Meas. Freq. [MHz]	Meas. value [dB]	Limit value [dB]	Calc. margin [dB]
1	1.0	31.6	19.0	12.6
4	4.1	27.0	19.0	8.0
16	15.9	38.0	18.0	20.0
100	100.0	26.8	12.0	14.8
250	250.0	20.3	8.0	12.3

**ATTENUATION TO CROSSTALK RATIO, NEAR END (ACR-N).** From terminal end  
 Channel #1.. Worst case margin: 8.4 dB at 238.2 MHz for Blue/Green-Blue pair.

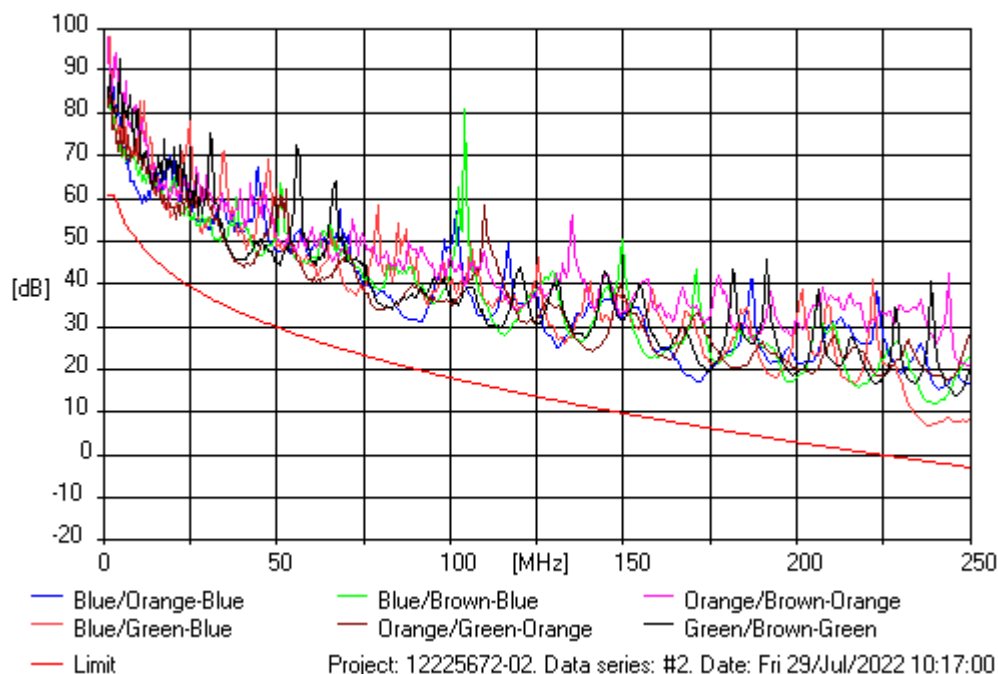

Table 6. Worst case margins at selected nominal frequencies.

Nominal Freq. [MHz]	Meas. Freq. [MHz]	Meas. value [dB]	Limit value [dB]	Calc. margin [dB]
1	1.0	81.8	61.0	20.8
4	4.1	71.4	58.6	12.8
16	15.9	61.8	45.0	16.8
100	100.0	35.8	18.2	17.6
250	250.0	8.4	-2.8	11.2

**PS ATT TO CROSSTALK RATIO , NEAR END (PSACR-N).** From terminal end  
 Channel #1. Worst case margin: 10.2 dB at 238.2 MHz for Blue pair.

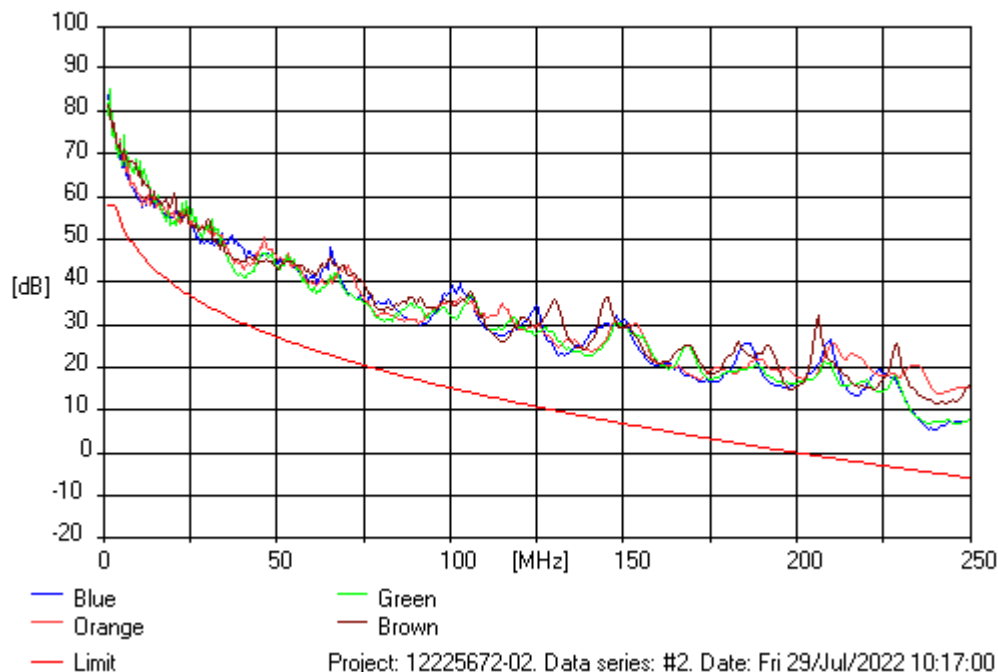

Table 7. Worst case margins at selected nominal frequencies.

Nominal Freq. [MHz]	Meas. Freq. [MHz]	Meas. value [dB]	Limit value [dB]	Calc. margin [dB]
1	1.0	79.5	58.0	21.5
4	4.1	69.6	56.1	13.5
16	15.9	58.9	42.3	16.6
100	100.0	32.3	15.4	16.9
250	250.0	7.7	-5.8	13.5

**TRANSVERSE CONVERSION LOSS (TCL). From terminal end**

Channel #1. Worst case margin: 22.5 dB at 109.9 MHz for Brown pair.

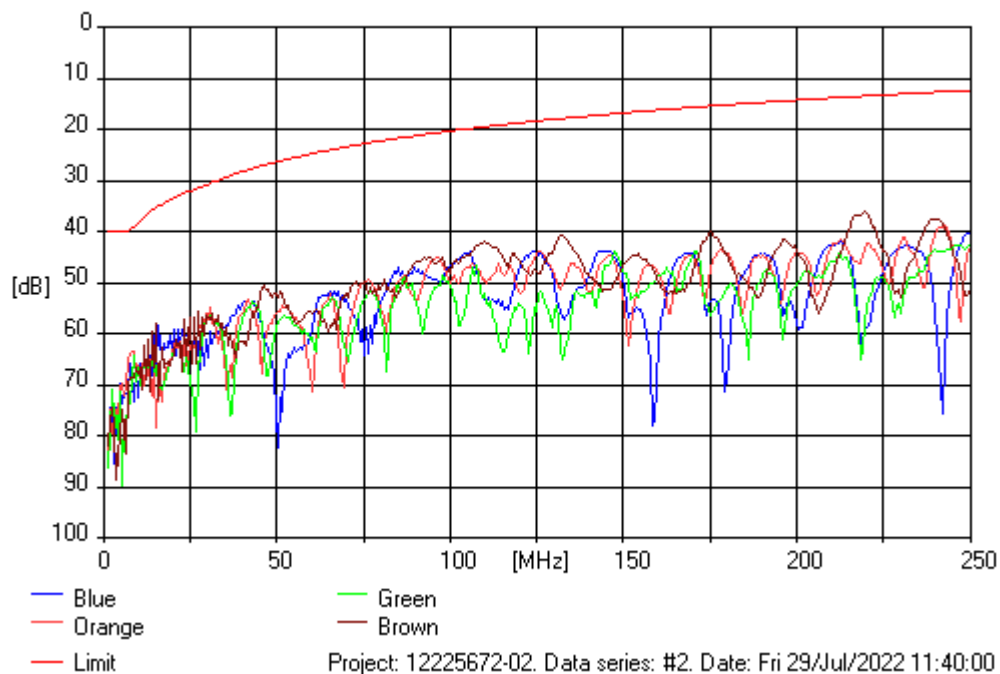

Table 8. Worst case margins at selected nominal frequencies.

Nominal Freq. [MHz]	Meas. Freq. [MHz]	Meas. value [dB]	Limit value [dB]	Calc. margin [dB]
1	1.0	81.9	40.0	41.9
4	4.1	76.4	40.0	36.4
16	15.9	58.2	35.0	23.3
100	100.0	46.6	20.3	26.2
250	250.0	40.2	12.3	27.8

**NEAR END CROSSTALK (NEXT). From equipment end**

Channel #1. Worst case margin: 5.8 dB at 227.6 MHz for Green /Brown pair.

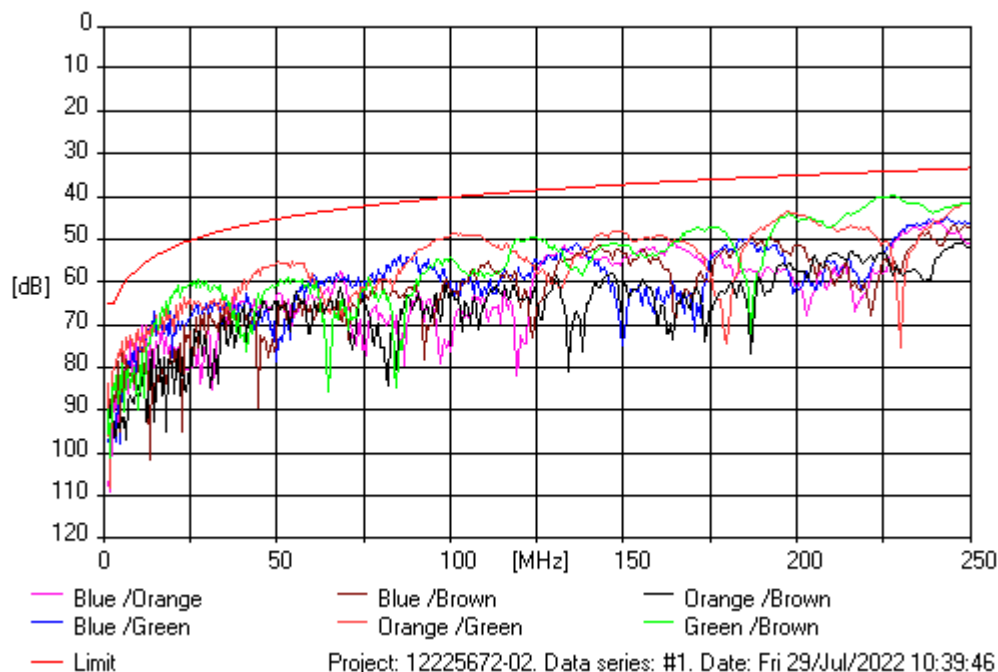

Table 9. Worst case margins at selected nominal frequencies.

Nominal Freq. [MHz]	Meas. Freq. [MHz]	Meas. value [dB]	Limit value [dB]	Calc. margin [dB]
1	1.0	83.6	65.0	18.6
4	4.1	76.4	62.8	13.5
16	15.9	71.0	53.3	17.8
100	100.0	49.1	39.9	9.1
250	250.0	41.3	33.1	8.1



**PS NEAR END CROSSTALK(PSNEXT).** From equipment end  
 Channel #1. Worst case margin: 7.4 dB at 248.1 MHz for Green pair.

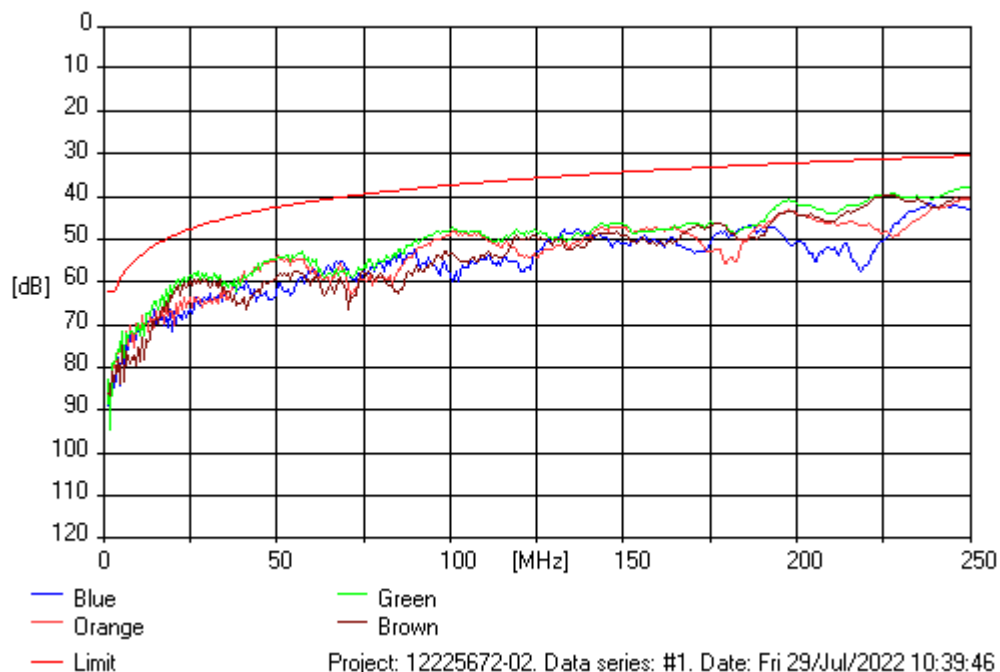

Table 10. Worst case margins at selected nominal frequencies.

Nominal Freq. [MHz]	Meas. Freq. [MHz]	Meas. value [dB]	Limit value [dB]	Calc. margin [dB]
1	1.0	82.5	62.0	20.5
4	4.1	75.5	60.3	15.1
16	15.9	66.5	50.6	15.9
100	100.0	47.6	37.1	10.5
250	250.0	37.8	30.2	7.6

**RETURN LOSS.** From equipment end

Channel #1. Worst case margin: 1.9 dB at 26.5 MHz for Orange pair.

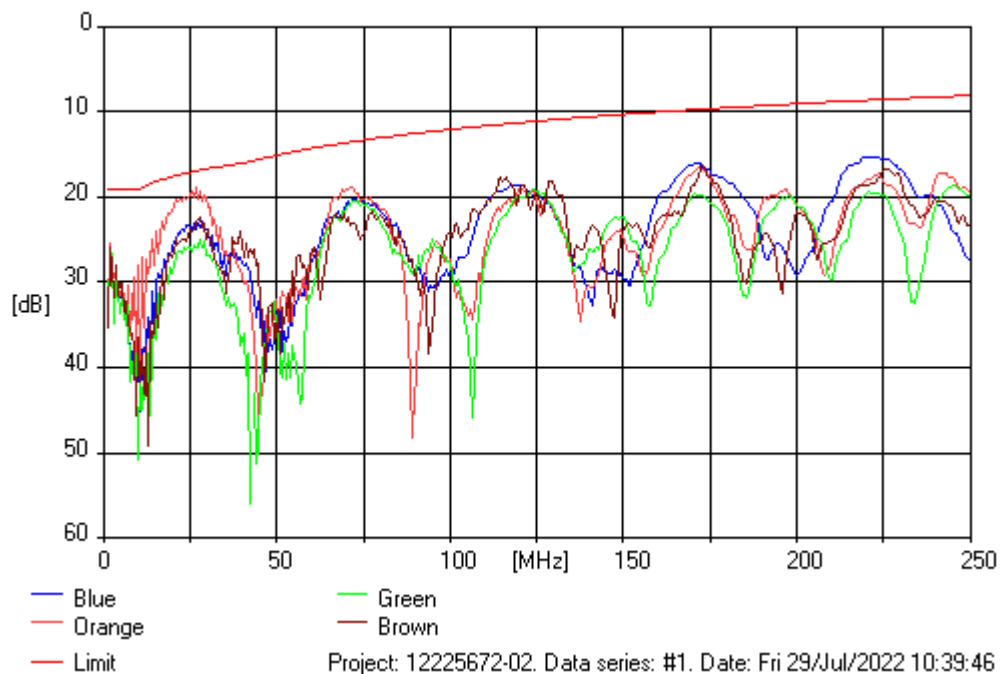

Table 11. Worst case margins at selected nominal frequencies.

Nominal Freq. [MHz]	Meas. Freq. [MHz]	Meas. value [dB]	Limit value [dB]	Calc. margin [dB]
1	1.0	32.3	19.0	13.3
4	4.1	30.3	19.0	11.3
16	15.9	26.5	18.0	8.5
100	100.0	24.1	12.0	12.1
250	250.0	19.4	8.0	11.4

**ATTENUATION TO CROSSTALK RATIO, NEAR END (ACR-N).** From equipment end  
 Channel #1. Worst case margin: 10.6 dB at 21.5 MHz for Green/Brown-Green pair.

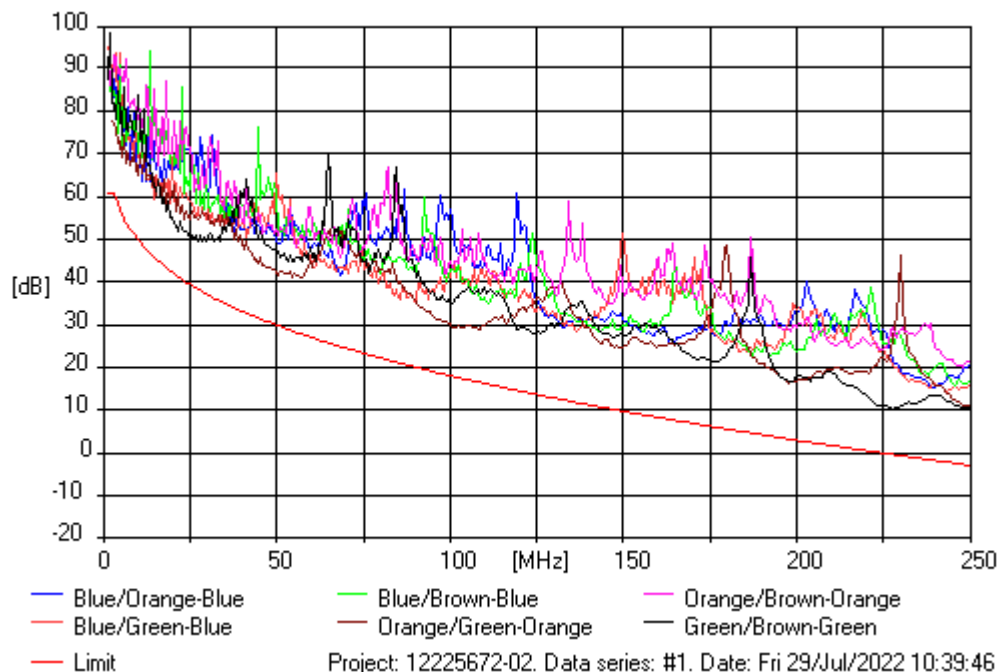

Table 12. Worst case margins at selected nominal frequencies.

Nominal Freq. [MHz]	Meas. Freq. [MHz]	Meas. value [dB]	Limit value [dB]	Calc. margin [dB]
1	1.0	81.8	61.0	20.8
4	4.1	72.8	58.6	14.2
16	15.9	63.7	45.0	18.7
100	100.0	30.4	18.2	12.2
250	250.0	10.4	-2.8	13.2

**PS ATT TO CROSSTALK RATIO , NEAR END (PSACR-N).** From equipment end  
 Channel #1. Worst case margin: 11.8 dB at 24.7 MHz for Green pair.

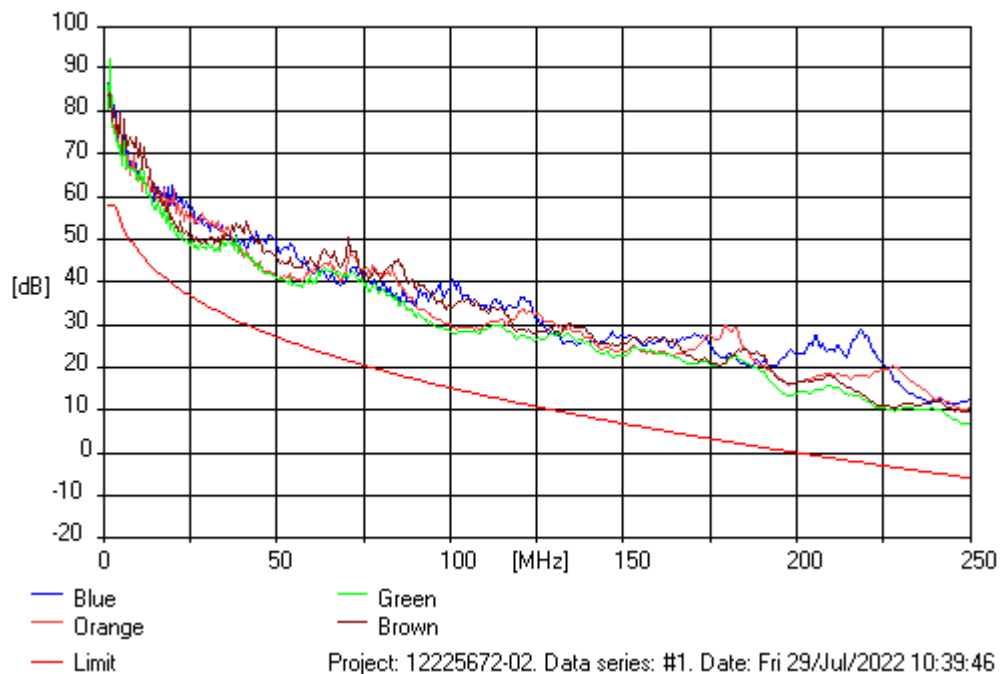

Table 13. Worst case margins at selected nominal frequencies.

Nominal Freq. [MHz]	Meas. Freq. [MHz]	Meas. value [dB]	Limit value [dB]	Calc. margin [dB]
1	1.0	80.7	58.0	22.7
4	4.1	71.8	56.1	15.7
16	15.9	59.1	42.3	16.8
100	100.0	28.7	15.4	13.3
250	250.0	6.9	-5.8	12.7

**TRANSVERSE CONVERSION LOSS (TCL).** From equipment end  
 Channel #1. Worst case margin: 20.6 dB at 93.1 MHz for Orange pair.

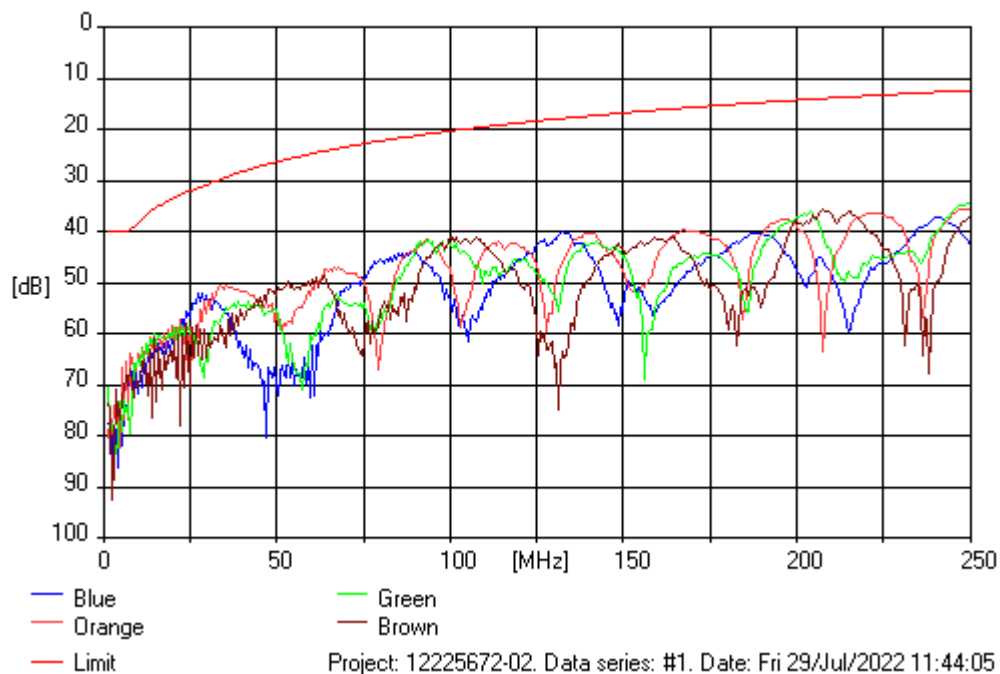

Table 14. Worst case margins at selected nominal frequencies.

Nominal Freq. [MHz]	Meas. Freq. [MHz]	Meas. value [dB]	Limit value [dB]	Calc. margin [dB]
1	1.0	70.5	40.0	30.5
4	4.1	73.1	40.0	33.1
16	15.9	60.4	35.0	25.4
100	100.0	41.0	20.3	20.7
250	250.0	34.5	12.3	22.2

**BALANCED MODE ATTENUATION.**

Channel #1. Worst case margin: 0.6 dB at 4.1 MHz for Green pair.

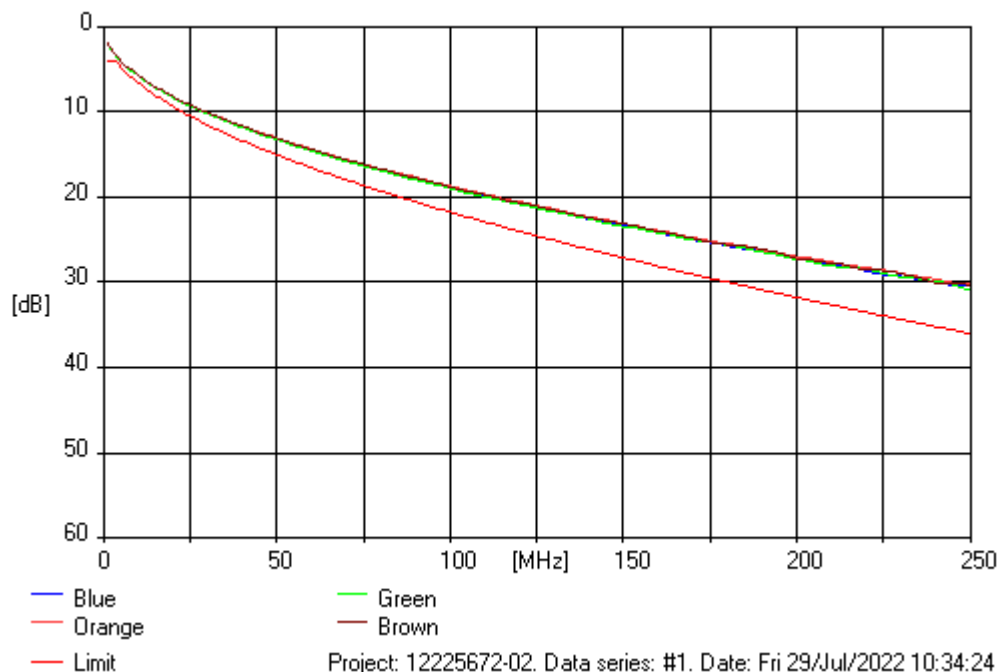
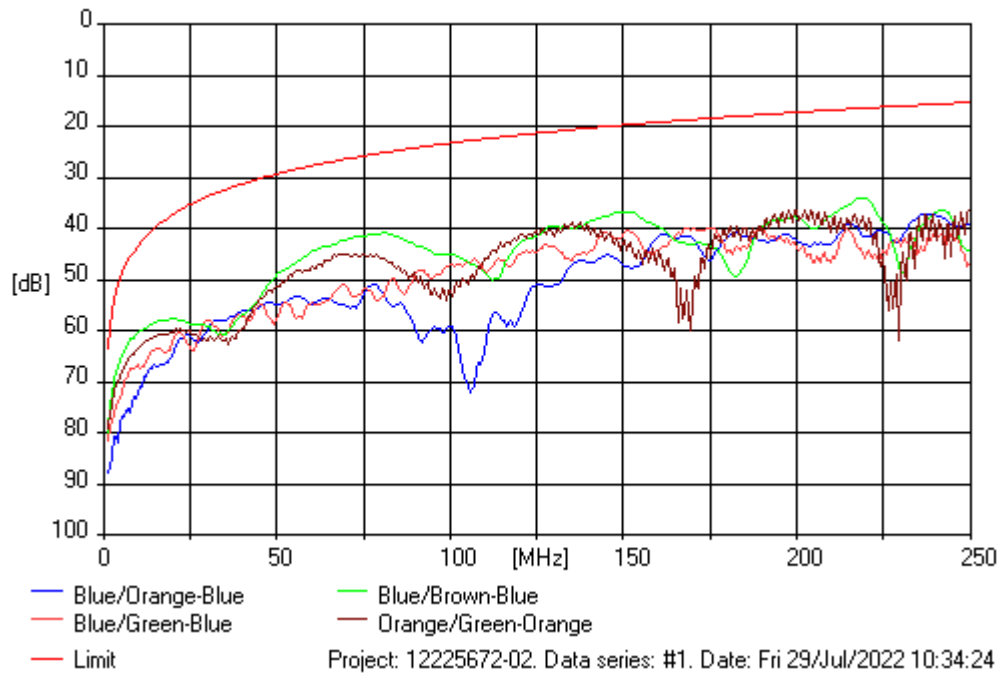

Table 15. Worst case margins at selected nominal frequencies.

Nominal Freq. [MHz]	Meas. Freq. [MHz]	Meas. value [dB]	Limit value [dB]	Calc. margin [dB]
1	1.0	1.8	4.0	2.2
4	4.1	3.7	4.2	0.6
16	15.9	7.4	8.3	0.9
100	100.0	18.9	21.7	2.8
250	250.0	30.8	35.9	5.1

**ATTENUATION TO CROSSTALK RATIO - FAR (ACR-F).**

Channel #1. Worst case margin: 15.2 dB at 1.6 MHz for Blue/Brown-Blue pair.



**ATTENUATION TO CROSSTALK RATIO - FAR (ACR-F).**

Channel #1. Worst case margin: 12.4 dB at 250 MHz for Green/Brown-Green pair.

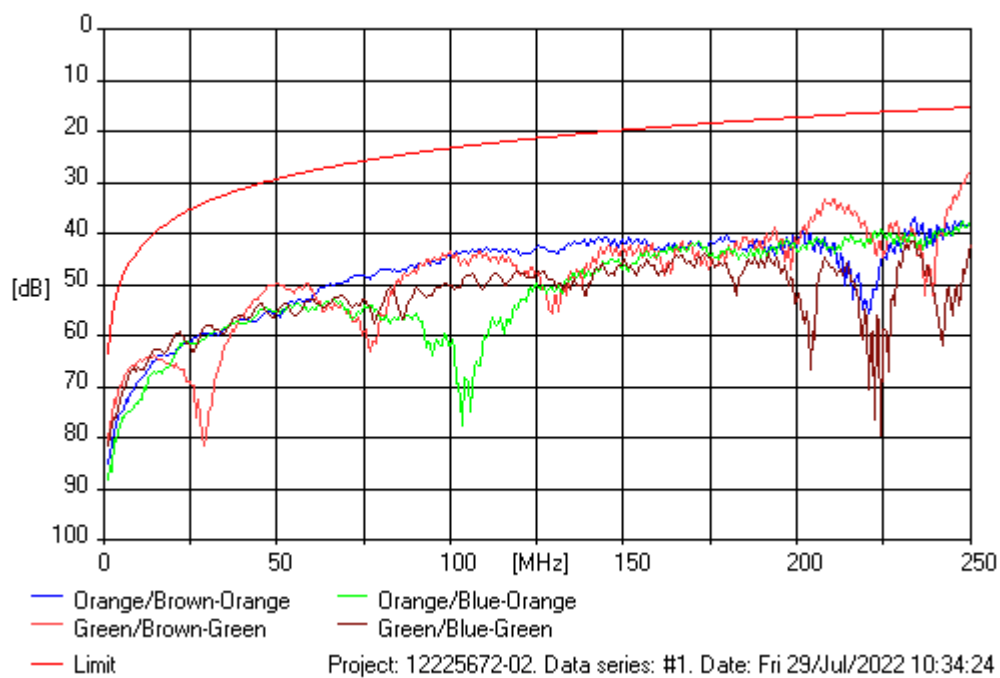

**ATTENUATION TO CROSSTALK RATIO - FAR (ACR-F).**

Channel #1. Worst case margin: 15.3 dB at 1.6 MHz for Brown/Blue-Brown pair.

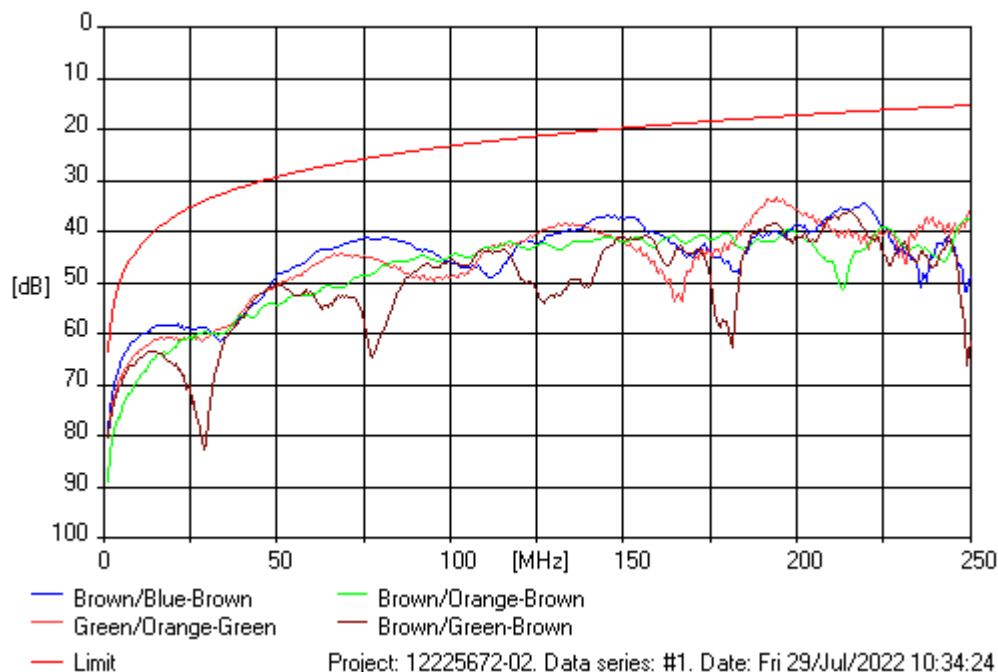

Table 16. Worst case margins at selected nominal frequencies.

Nominal Freq. [MHz]	Meas. Freq. [MHz]	Meas. value [dB]	Limit value [dB]	Calc. margin [dB]
1	1.0	79.0	63.3	15.7
4	4.1	67.5	51.0	16.5
16	15.9	58.0	39.2	18.8
100	100.0	43.6	23.3	20.4
250	250.0	27.7	15.3	12.4



**PS SUM ATTENUATION TO CROSSTALK RATIO - FAR (PSACR-F).**

Channel #1. Worst case margin: 14.7 dB at 250 MHz for Green pair.

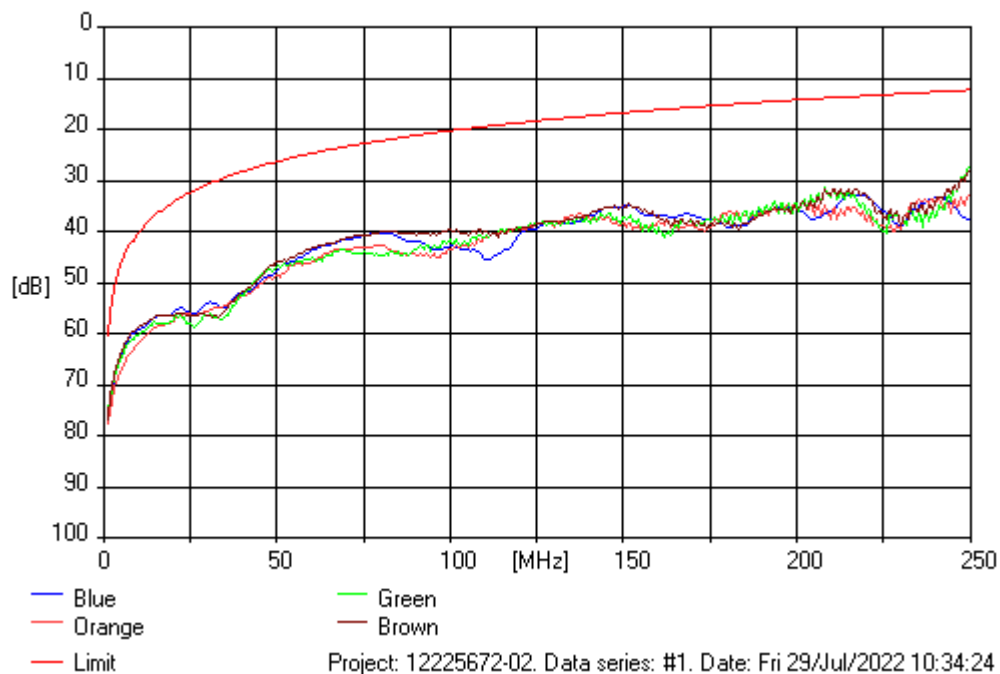

Table 17. Worst case margins at selected nominal frequencies.

Nominal Freq. [MHz]	Meas. Freq. [MHz]	Meas. value [dB]	Limit value [dB]	Calc. margin [dB]
1	1.0	75.4	60.3	15.1
4	4.1	65.5	48.0	17.5
16	15.9	56.4	36.2	20.2
100	100.0	39.5	20.3	19.2
250	250.0	27.0	12.3	14.7

**PROPAGATION DELAY.**

Channel #1. Worst case margin: 0.048  $\mu$ s at 245.6 MHz for Green pair.

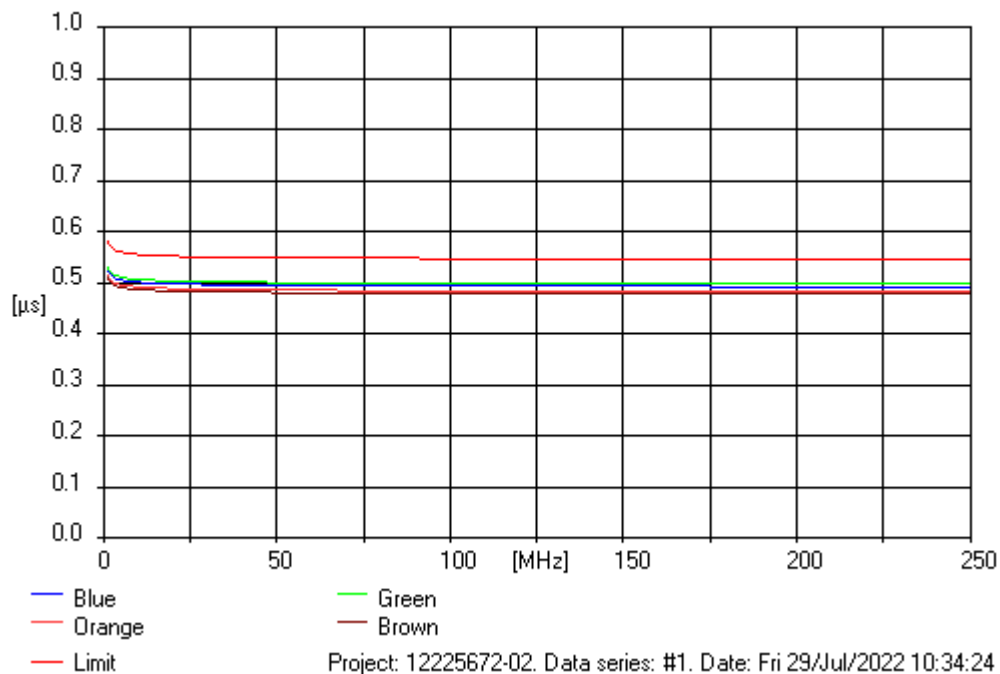

Table 18. Worst case margins at selected nominal frequencies.

Nominal Freq. [MHz]	Meas. Freq. [MHz]	Meas. value [ns]	Limit value [ns]	Calc. margin [ns]
1	1.0	529	580	51
4	4.1	513	562	49
16	15.9	504	553	49
100	100.0	499	548	48
250	250.0	498	546	48

**DELAY SKEW.**

Channel #1. Worst case margin: 30.1 ns.

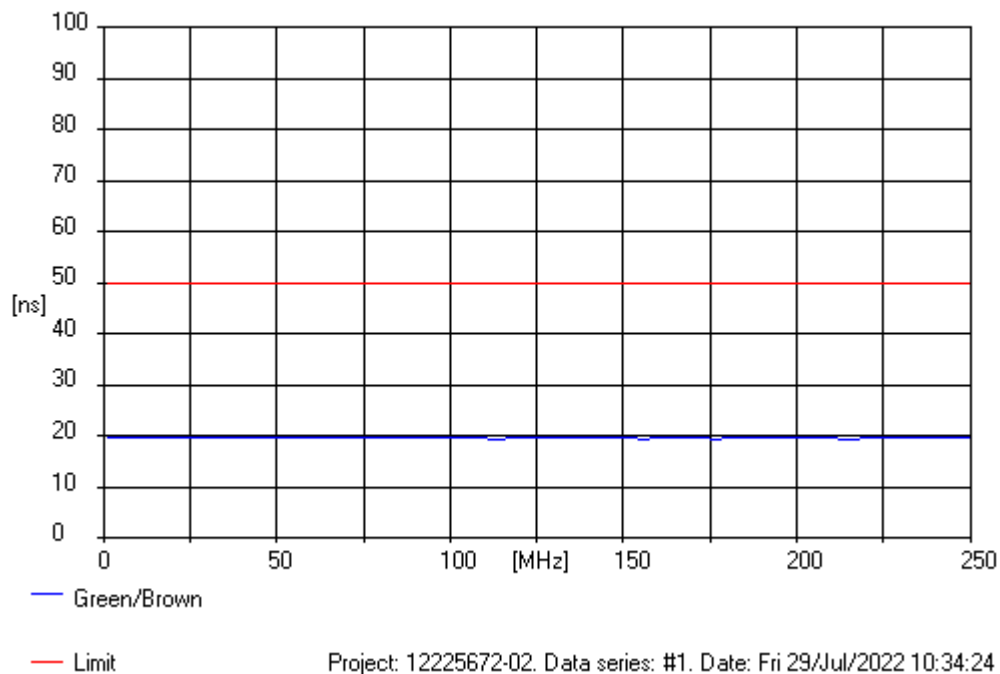

Table 19. Worst case margins at selected nominal frequencies.

Nominal Freq. [MHz]	Meas. Freq. [MHz]	Meas. value [ns]	Limit value [ns]	Calc. margin [ns]
1	1.0	19.9	50.0	30.1
4	4.1	19.7	50.0	30.3
16	15.9	19.6	50.0	30.4
100	100.0	19.5	50.0	30.5
250	250.0	19.5	50.0	30.5

4.4 High frequency transmission test results. Channel #2 (15 m horizontal cable)

**NEAR END CROSSTALK (NEXT).** From terminal end

Channel #2. Worst case margin: 3.2 dB at 237.6 MHz for Blue /Green pair.

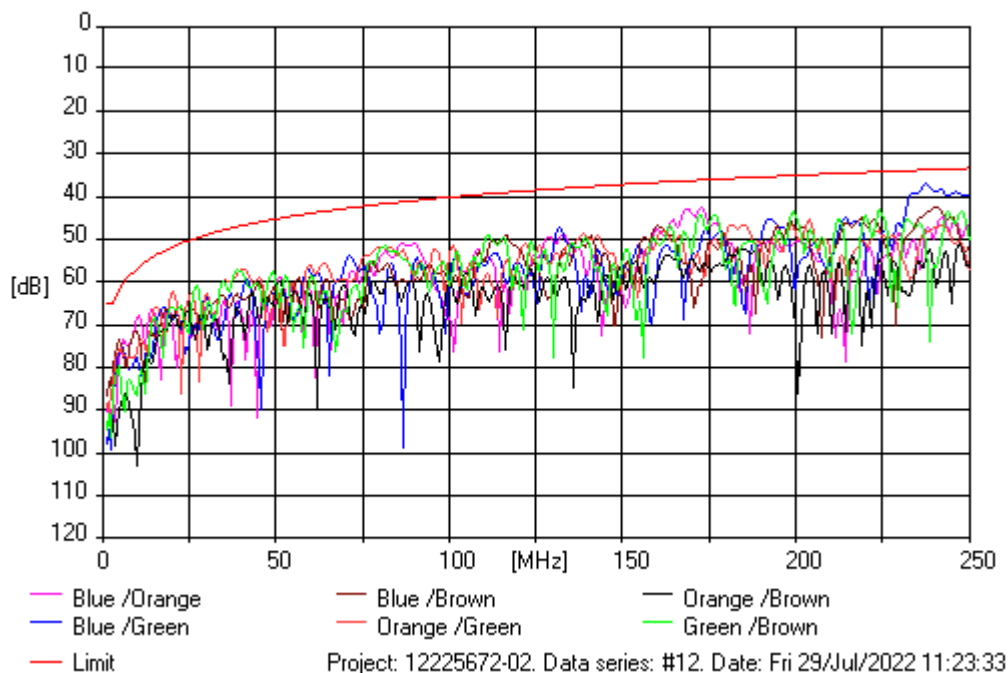

Table 20. Worst case margins at selected nominal frequencies.

Nominal Freq. [MHz]	Meas. Freq. [MHz]	Meas. value [dB]	Limit value [dB]	Calc. margin [dB]
1	1.0	86.6	65.0	21.6
4	4.1	75.2	62.8	12.3
16	15.9	65.7	53.3	12.5
100	100.0	53.6	39.9	13.7
250	250.0	39.5	33.1	6.4

**PS NEAR END CROSSTALK(PSNEXT).** From terminal end

Channel #2. Worst case margin: 5.1 dB at 237.6 MHz for Blue pair.

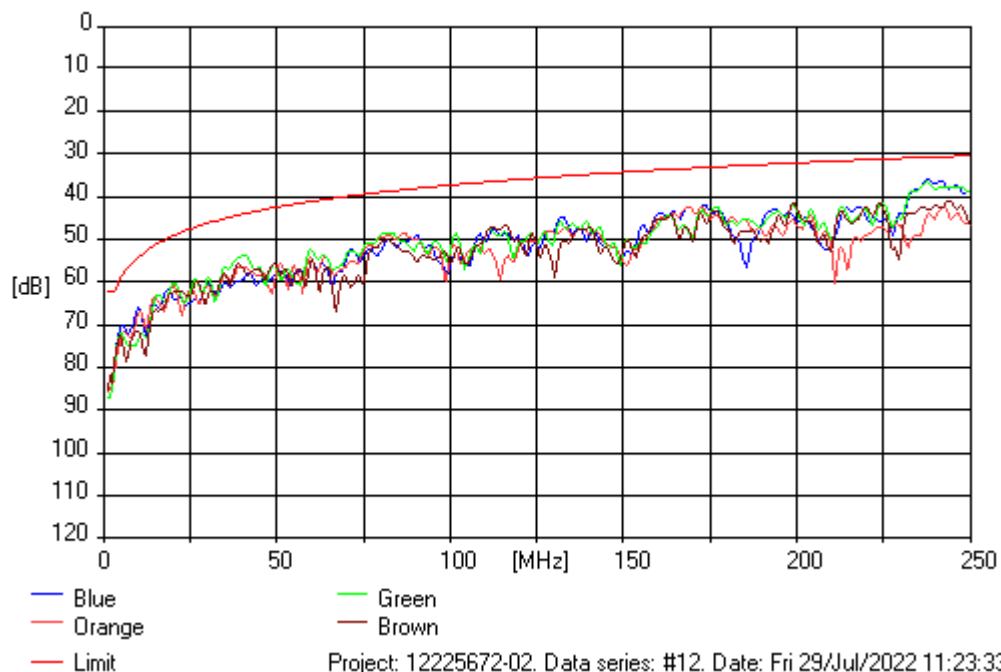

Table 21. Worst case margins at selected nominal frequencies.

Nominal Freq. [MHz]	Meas. Freq. [MHz]	Meas. value [dB]	Limit value [dB]	Calc. margin [dB]
1	1.0	84.9	62.0	22.9
4	4.1	73.2	60.3	12.9
16	15.9	62.9	50.6	12.2
100	100.0	52.0	37.1	14.9
250	250.0	38.4	30.2	8.2

**RETURN LOSS.** From terminal end

Channel #2. Worst case margin: 2.7 dB at 9.1 MHz for Orange pair.

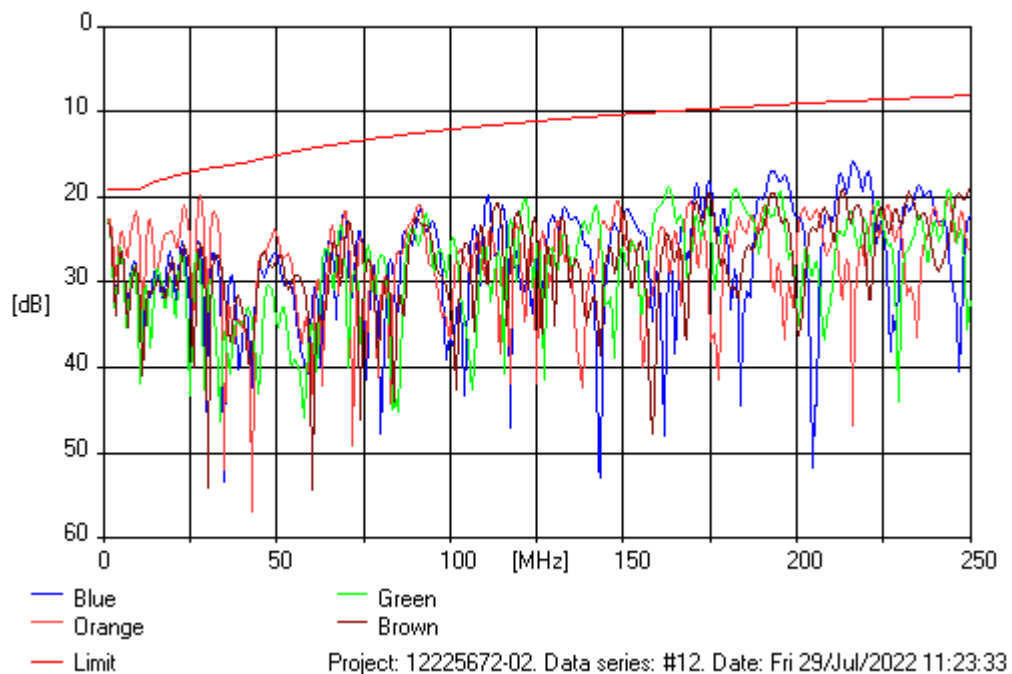

Table 22. Worst case margins at selected nominal frequencies.

Nominal Freq. [MHz]	Meas. Freq. [MHz]	Meas. value [dB]	Limit value [dB]	Calc. margin [dB]
1	1.0	22.7	19.0	3.7
4	4.1	26.7	19.0	7.7
16	15.9	28.2	18.0	10.2
100	100.0	25.7	12.0	13.7
250	250.0	18.8	8.0	10.7

**ATTENUATION TO CROSSTALK RATIO, NEAR END (ACR-N).** From terminal end  
 Channel #2. Worst case margin: 14.7 dB at 4.7 MHz for Blue/Brown-Blue pair.

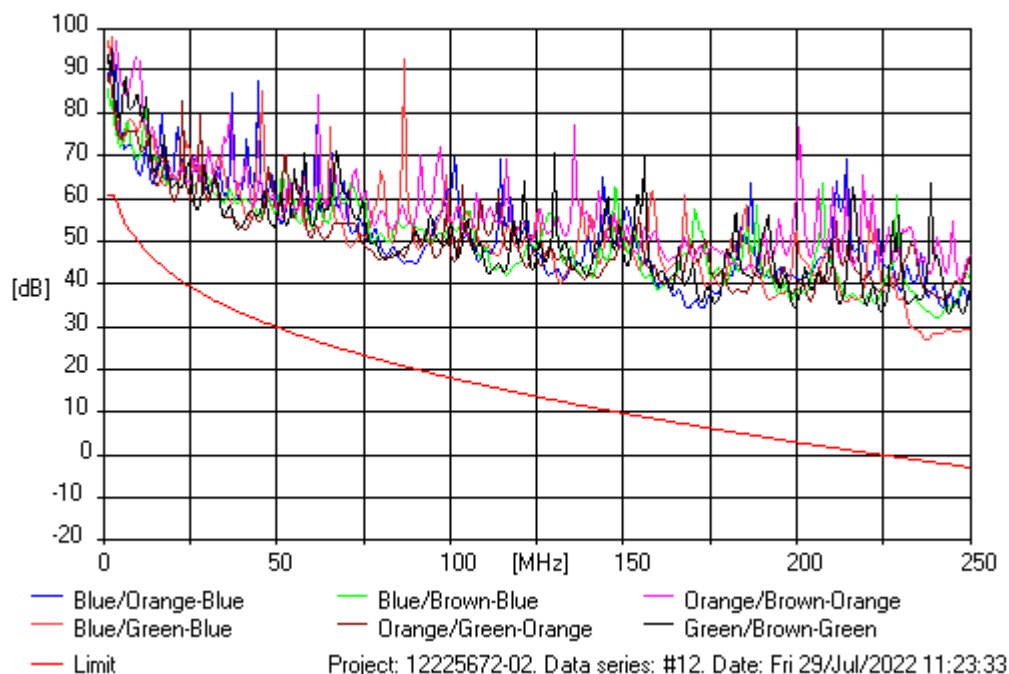

Table 23. Worst case margins at selected nominal frequencies.

Nominal Freq. [MHz]	Meas. Freq. [MHz]	Meas. value [dB]	Limit value [dB]	Calc. margin [dB]
1	1.0	86.1	61.0	25.1
4	4.1	74.0	58.6	15.4
16	15.9	63.4	45.0	18.5
100	100.0	47.6	18.2	29.4
250	250.0	29.6	-2.8	32.4

**PS ATT TO CROSSTALK RATIO , NEAR END (PSACR-N).** From terminal end  
 Channel #2. Worst case margin: 14.6 dB at 4.7 MHz for Blue pair.

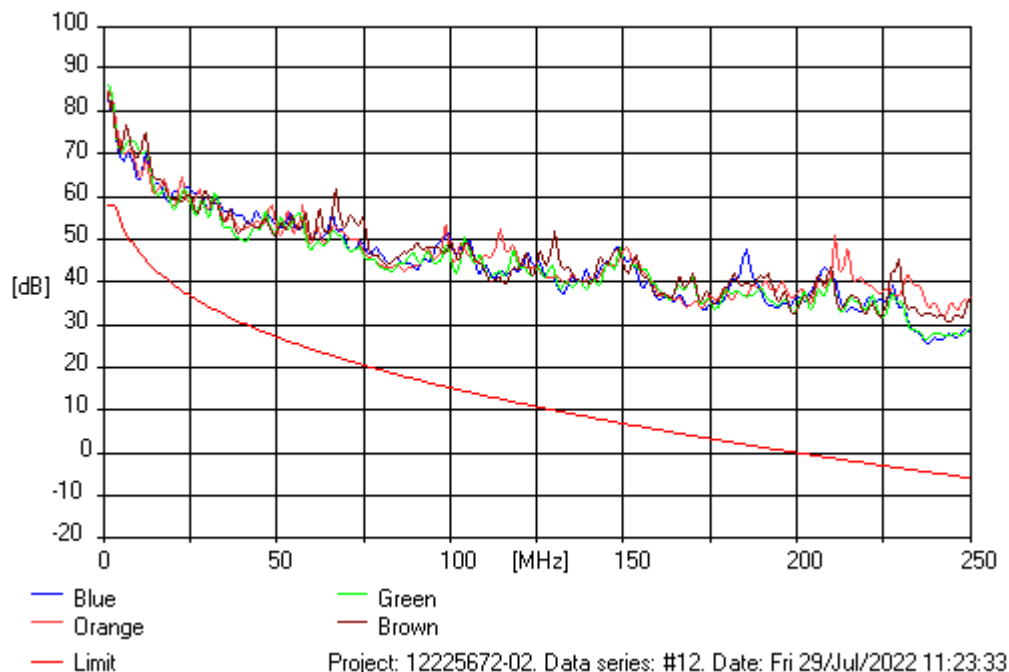

Table 24. Worst case margins at selected nominal frequencies.

Nominal Freq. [MHz]	Meas. Freq. [MHz]	Meas. value [dB]	Limit value [dB]	Calc. margin [dB]
1	1.0	84.3	58.0	26.3
4	4.1	72.1	56.1	16.0
16	15.9	60.6	42.3	18.2
100	100.0	45.9	15.4	30.6
250	250.0	28.5	-5.8	34.3



**TRANSVERSE CONVERSION LOSS (TCL).** From terminal end  
 Channel #2. Worst case margin: 16.1 dB at 33.4 MHz for Brown pair.

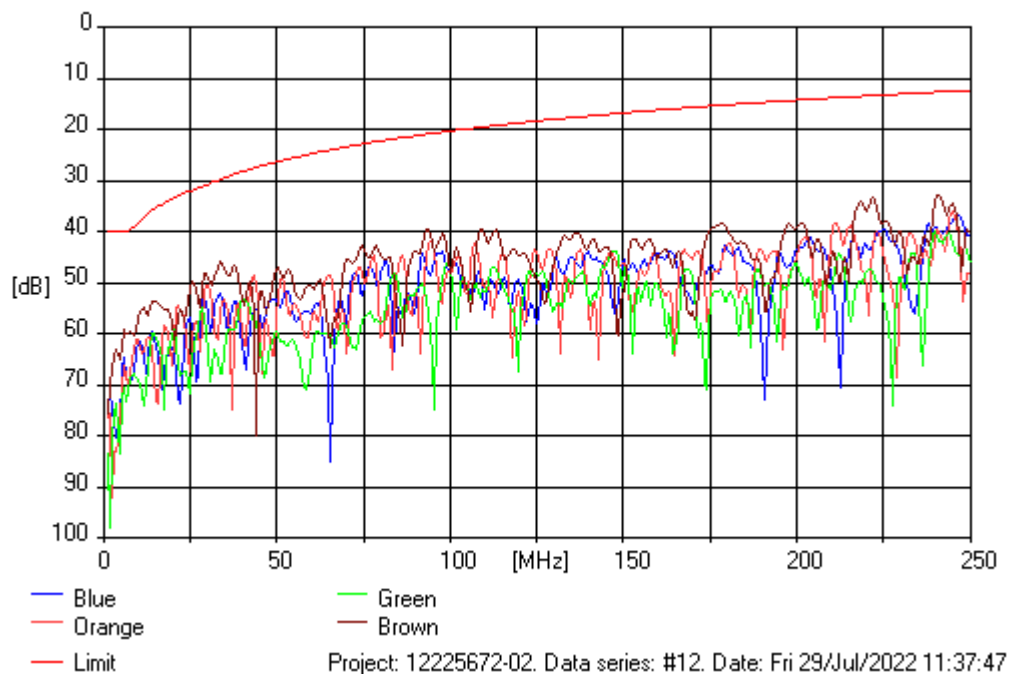

Table 25. Worst case margins at selected nominal frequencies.

Nominal Freq. [MHz]	Meas. Freq. [MHz]	Meas. value [dB]	Limit value [dB]	Calc. margin [dB]
1	1.0	74.4	40.0	34.4
4	4.1	63.7	40.0	23.7
16	15.9	54.1	35.0	19.1
100	100.0	47.2	20.3	26.9
250	250.0	40.4	12.3	28.0

**NEAR END CROSSTALK (NEXT).** From equipment end

Channel #2. Worst case margin: 3.8 dB at 227 MHz for Green /Brown pair.

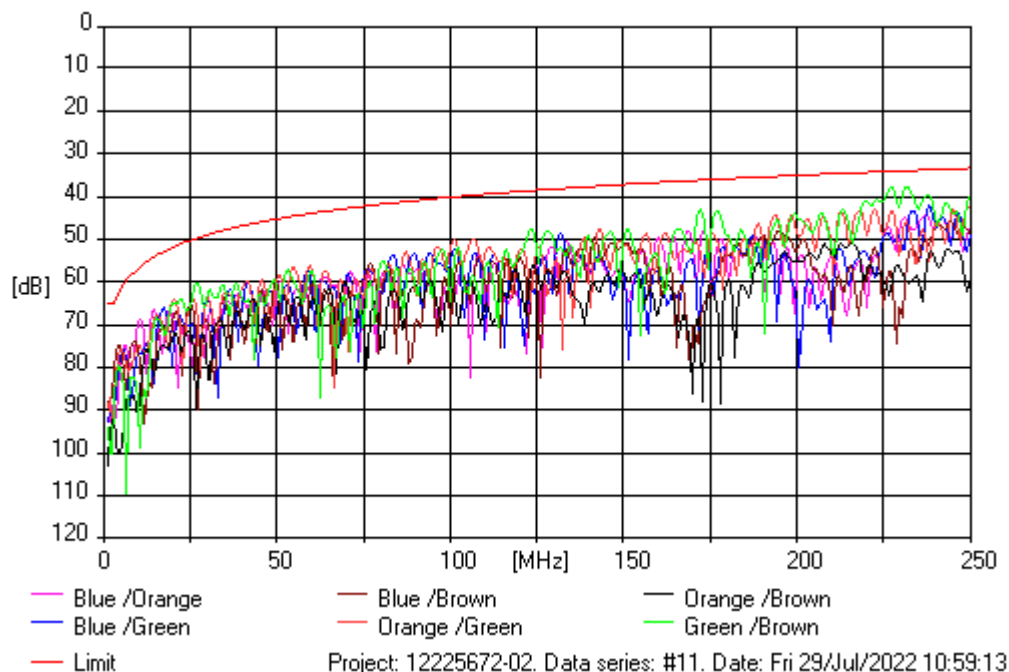

Table 26. Worst case margins at selected nominal frequencies.

Nominal Freq. [MHz]	Meas. Freq. [MHz]	Meas. value [dB]	Limit value [dB]	Calc. margin [dB]
1	1.0	88.9	65.0	23.9
4	4.1	74.9	62.8	12.0
16	15.9	67.7	53.3	14.4
100	100.0	51.8	39.9	11.8
250	250.0	39.4	33.1	6.3

**PS NEAR END CROSSTALK(PSNEXT).** From equipment end  
 Channel #2. Worst case margin: 5.4 dB at 227 MHz for Green pair.

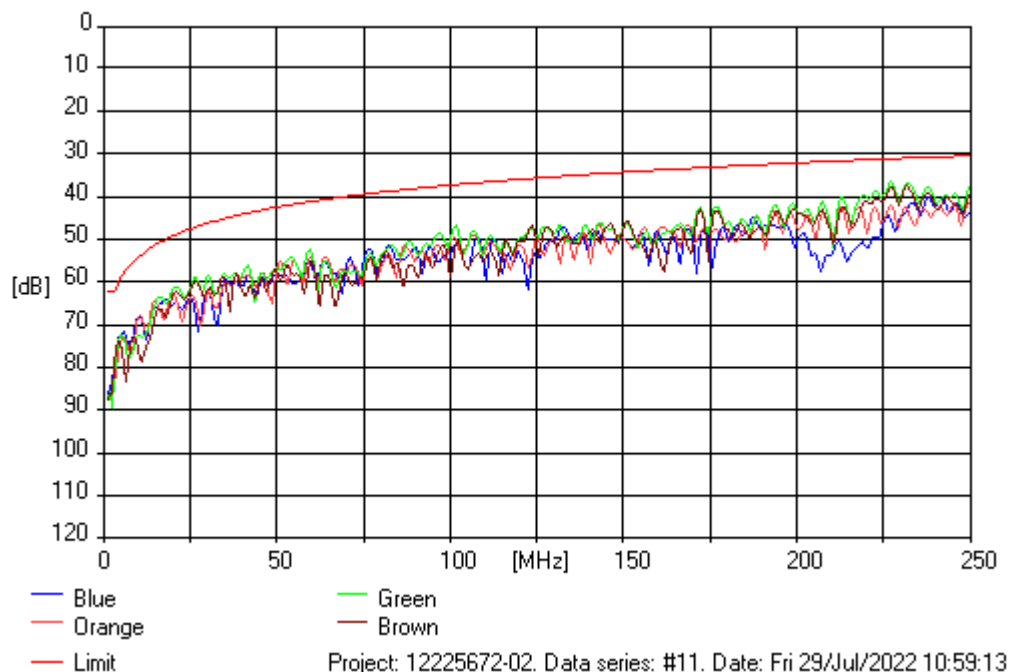

Table 27. Worst case margins at selected nominal frequencies.

Nominal Freq. [MHz]	Meas. Freq. [MHz]	Meas. value [dB]	Limit value [dB]	Calc. margin [dB]
1	1.0	86.1	62.0	24.1
4	4.1	73.5	60.3	13.2
16	15.9	63.5	50.6	12.8
100	100.0	49.9	37.1	12.9
250	250.0	37.2	30.2	7.1

**RETURN LOSS.** From equipment end

Channel #2. Worst case margin: 1.4 dB at 27.8 MHz for Orange pair.

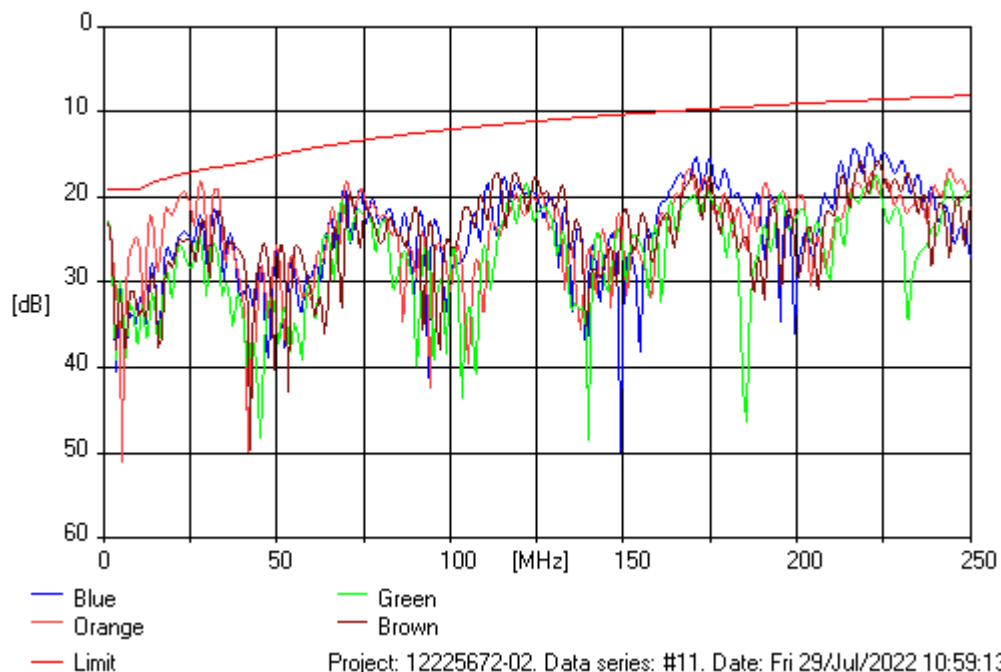

Table 28. Worst case margins at selected nominal frequencies.

Nominal Freq. [MHz]	Meas. Freq. [MHz]	Meas. value [dB]	Limit value [dB]	Calc. margin [dB]
1	1.0	22.7	19.0	3.7
4	4.1	31.5	19.0	12.5
16	15.9	28.7	18.0	10.8
100	100.0	25.4	12.0	13.4
250	250.0	18.9	8.0	10.9

**ATTENUATION TO CROSSTALK RATIO, NEAR END (ACR-N).** From equipment end  
 Channel #2. Worst case margin: 15.1 dB at 4.1 MHz for Blue/Brown-Blue pair.

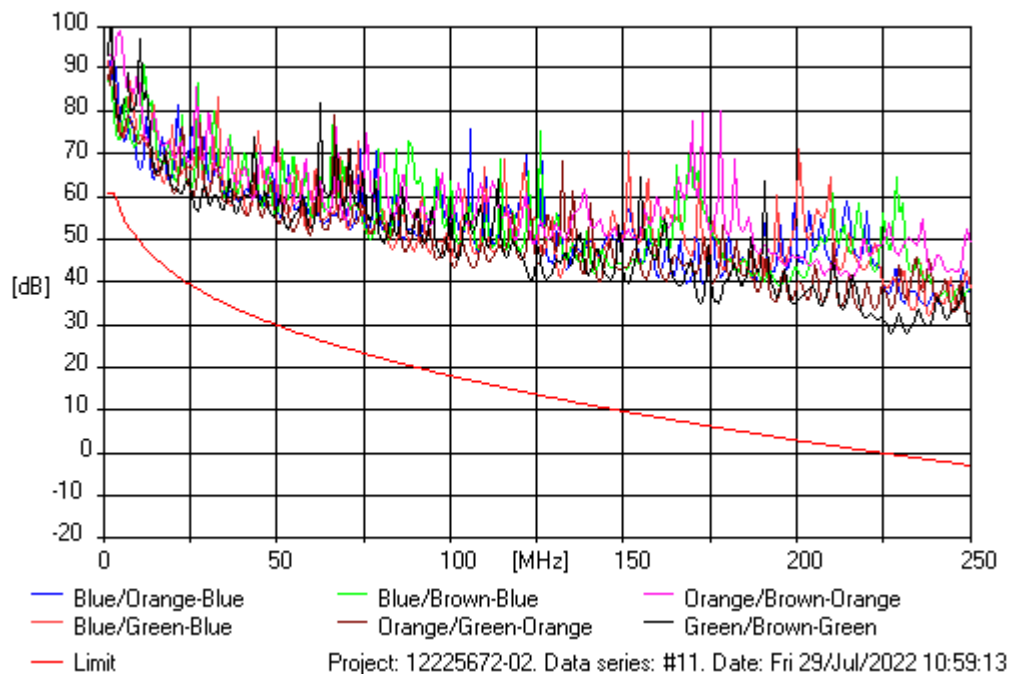

Table 29. Worst case margins at selected nominal frequencies.

Nominal Freq. [MHz]	Meas. Freq. [MHz]	Meas. value [dB]	Limit value [dB]	Calc. margin [dB]
1	1.0	88.3	61.0	27.3
4	4.1	73.7	58.6	15.1
16	15.9	65.3	45.0	20.4
100	100.0	45.7	18.2	27.5
250	250.0	29.2	-2.8	32.1

**PS ATT TO CROSSTALK RATIO , NEAR END (PSACR-N).** From equipment end  
 Channel #2. Worst case margin: 16.1 dB at 4.7 MHz for Blue pair.

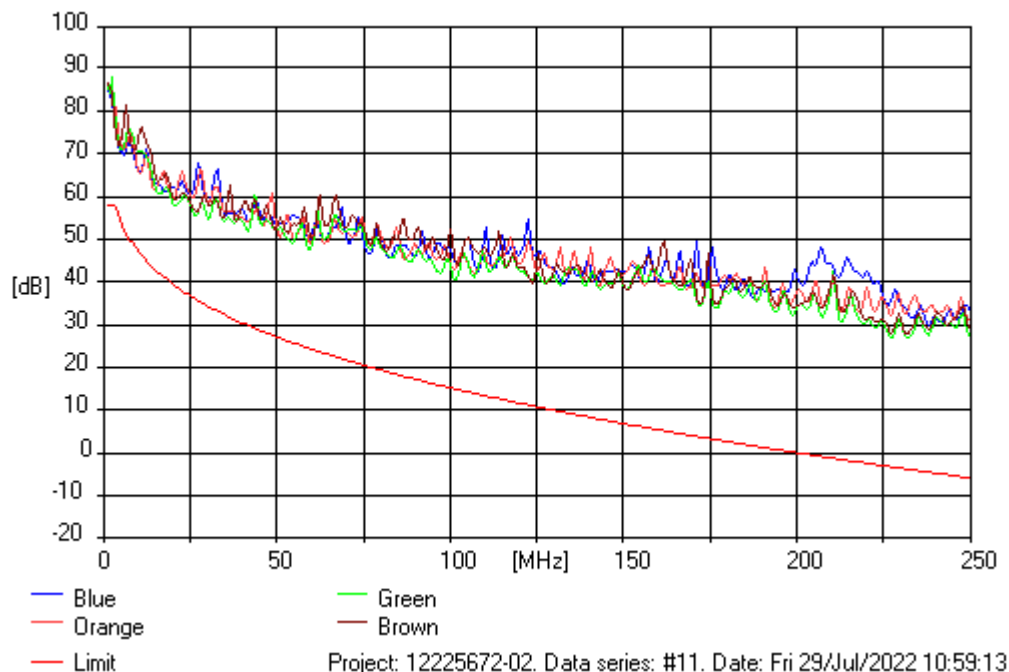

Table 30. Worst case margins at selected nominal frequencies.

Nominal Freq. [MHz]	Meas. Freq. [MHz]	Meas. value [dB]	Limit value [dB]	Calc. margin [dB]
1	1.0	85.5	58.0	27.5
4	4.1	72.4	56.1	16.3
16	15.9	61.2	42.3	18.8
100	100.0	43.9	15.4	28.5
250	250.0	27.1	-5.8	32.9

**TRANSVERSE CONVERSION LOSS (TCL).** From equipment end  
 Channel #2. Worst case margin: 13.2 dB at 27.8 MHz for Green pair.

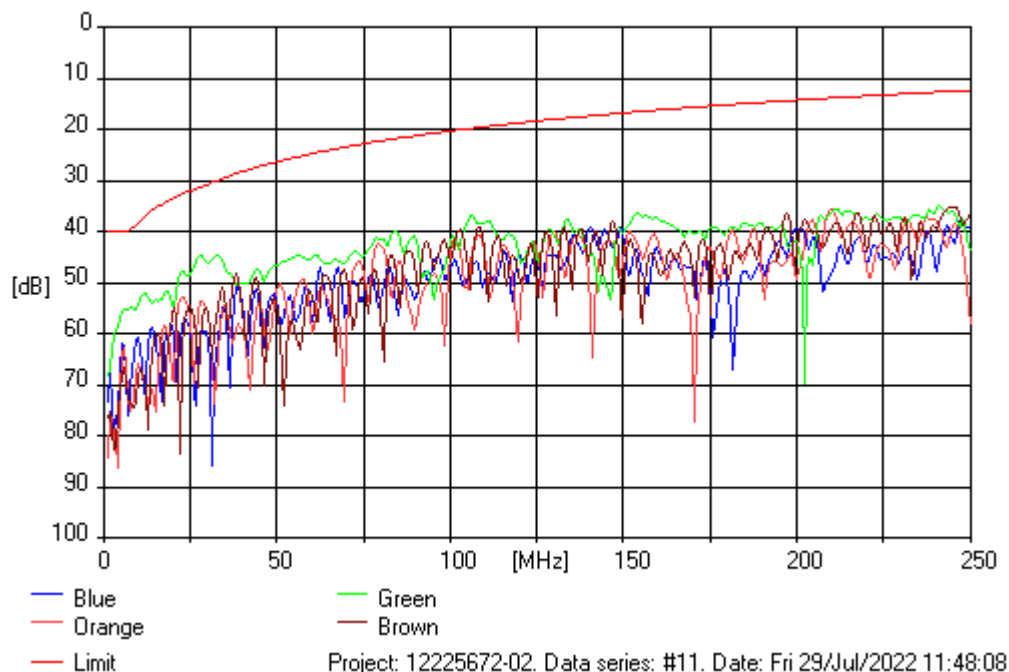

Table 31. Worst case margins at selected nominal frequencies.

Nominal Freq. [MHz]	Meas. Freq. [MHz]	Meas. value [dB]	Limit value [dB]	Calc. margin [dB]
1	1.0	68.1	40.0	28.1
4	4.1	58.4	40.0	18.4
16	15.9	53.7	35.0	18.7
100	100.0	42.0	20.3	21.7
250	250.0	36.6	12.3	24.2

**BALANCED MODE ATTENUATION.**

Channel #2. Worst case margin: 3 dB at 3.5 MHz for Green pair.

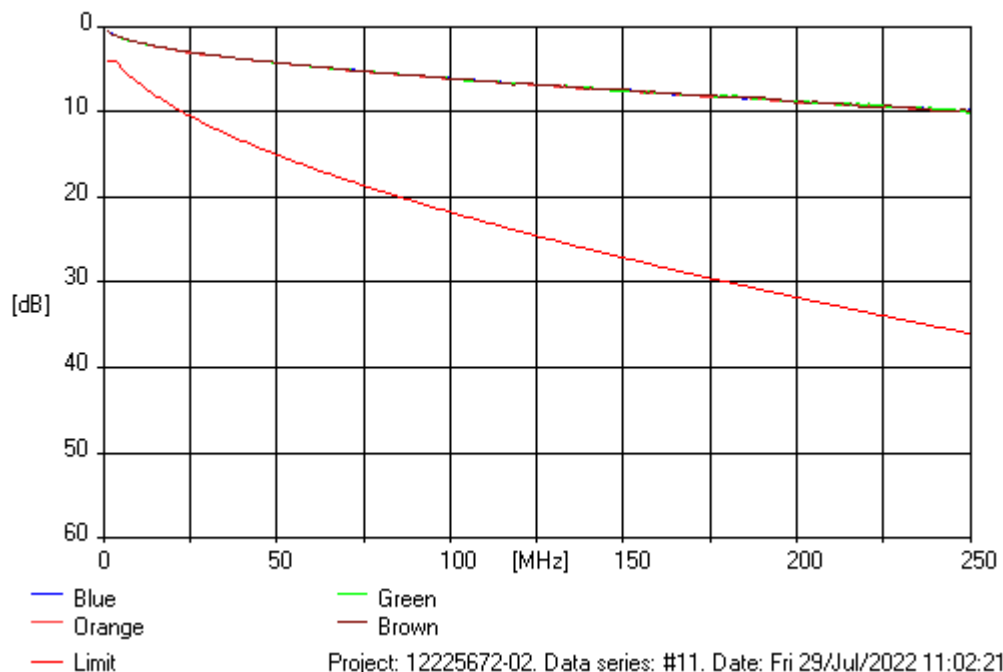

Table 32. Worst case margins at selected nominal frequencies.

Nominal Freq. [MHz]	Meas. Freq. [MHz]	Meas. value [dB]	Limit value [dB]	Calc. margin [dB]
1	1.0	0.5	4.0	3.5
4	4.1	1.1	4.2	3.1
16	15.9	2.3	8.3	6.0
100	100.0	6.1	21.7	15.6
250	250.0	10.1	35.9	25.8



**ATTENUATION TO CROSSTALK RATIO - FAR (ACR-F).**

Channel #2. Worst case margin: 15 dB at 1.6 MHz for Blue/Brown-Blue pair.

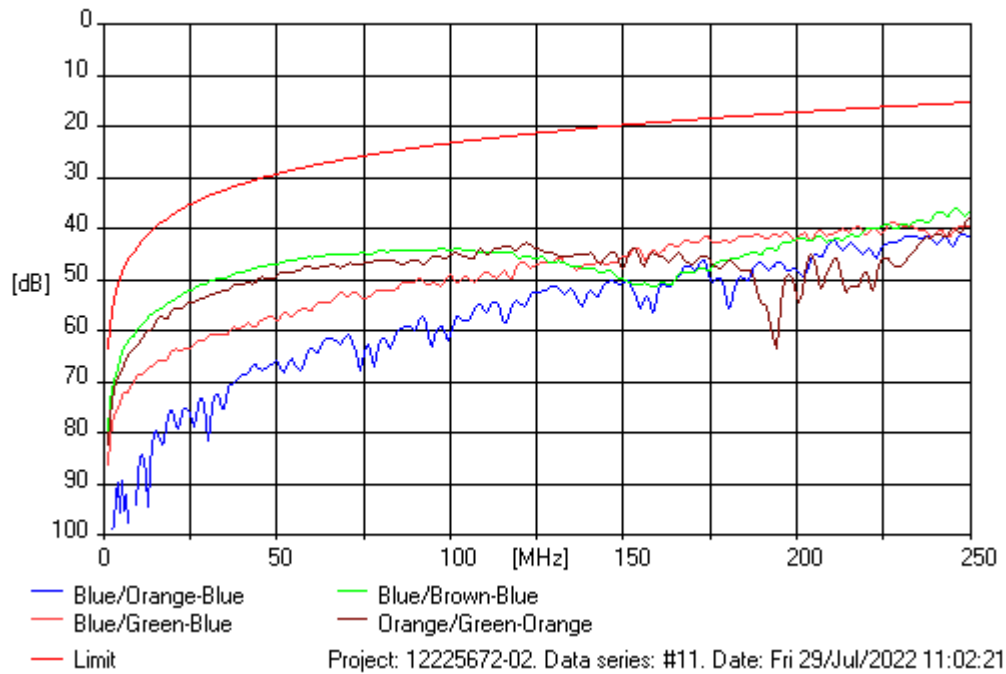

**ATTENUATION TO CROSSTALK RATIO - FAR (ACR-F).**

Channel #2. Worst case margin: 15.9 dB at 250 MHz for Green/Brown-Green pair.

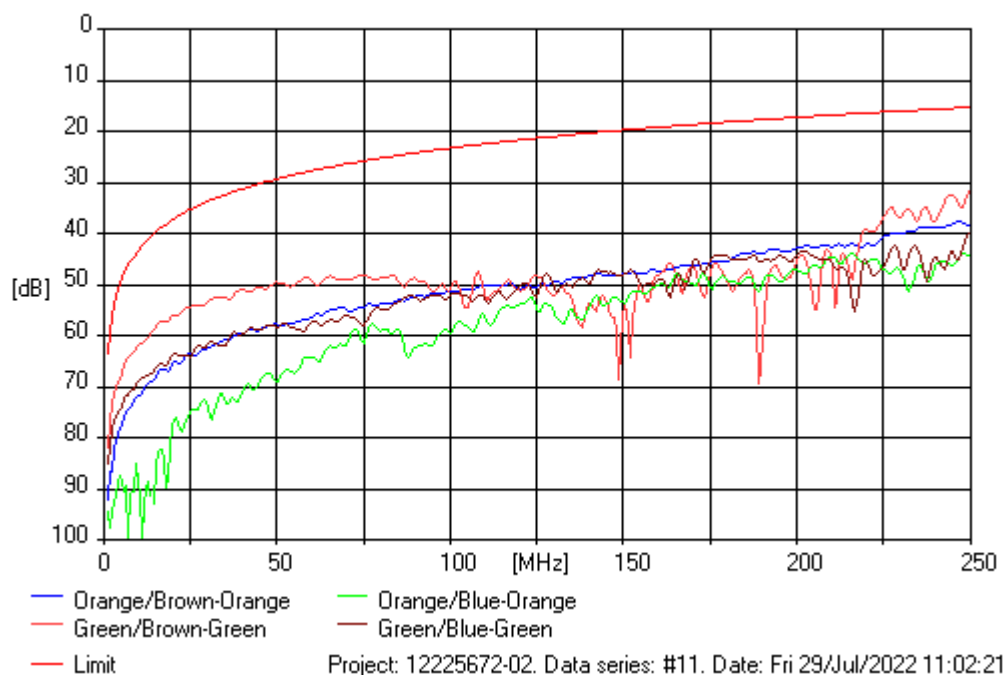

**ATTENUATION TO CROSSTALK RATIO - FAR (ACR-F).**

Channel #2. Worst case margin: 15 dB at 2.2 MHz for Brown/Blue-Brown pair.

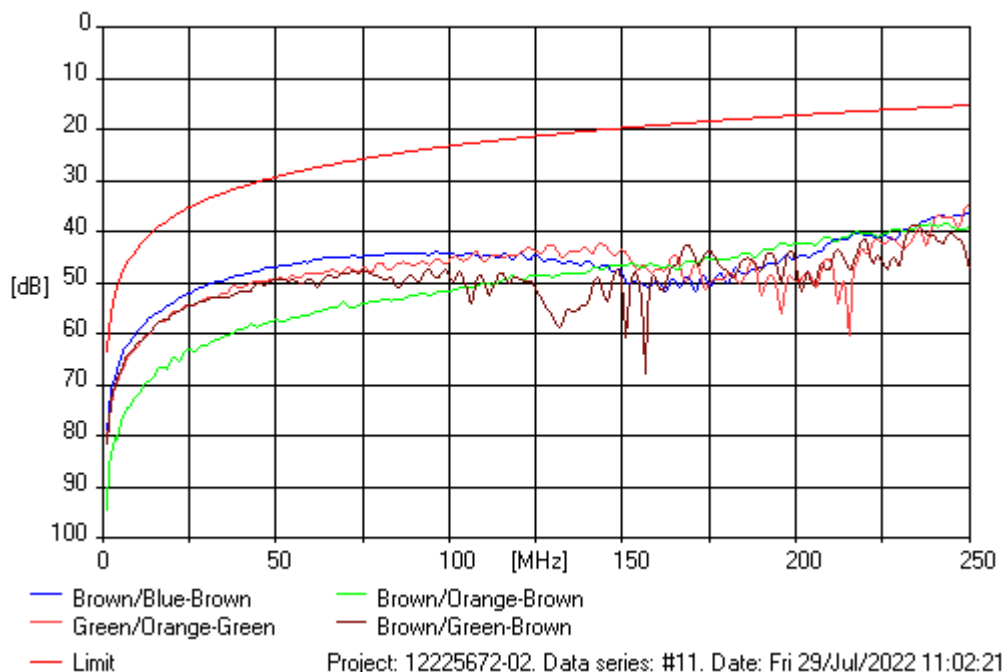

Table 33. Worst case margins at selected nominal frequencies.

Nominal Freq. [MHz]	Meas. Freq. [MHz]	Meas. value [dB]	Limit value [dB]	Calc. margin [dB]
1	1.0	79.8	63.3	16.5
4	4.1	67.3	51.0	16.4
16	15.9	55.8	39.2	16.6
100	100.0	44.2	23.3	20.9
250	250.0	31.2	15.3	15.9

**PS SUM ATTENUATION TO CROSSTALK RATIO - FAR (PSACR-F).**

Channel #2. Worst case margin: 16 dB at 1.6 MHz for Brown pair.

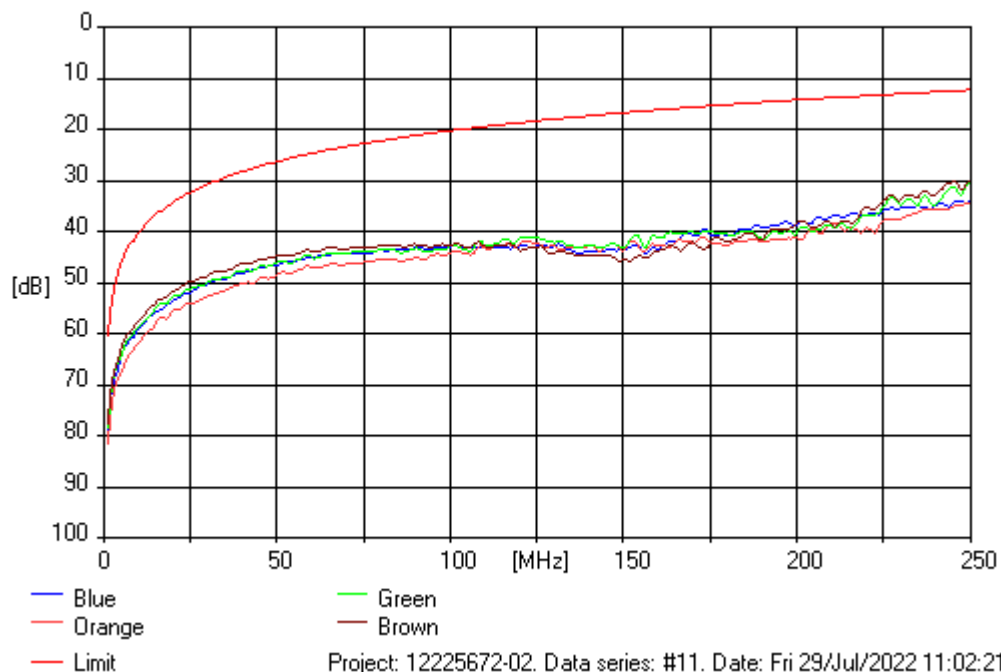

Table 34. Worst case margins at selected nominal frequencies.

Nominal Freq. [MHz]	Meas. Freq. [MHz]	Meas. value [dB]	Limit value [dB]	Calc. margin [dB]
1	1.0	77.6	60.3	17.3
4	4.1	65.2	48.0	17.2
16	15.9	53.4	36.2	17.2
100	100.0	42.7	20.3	22.4
250	250.0	29.7	12.3	17.4

**PROPAGATION DELAY.**

Channel #2. Worst case margin: 0.403  $\mu$ s at 249.4 MHz for Green pair.

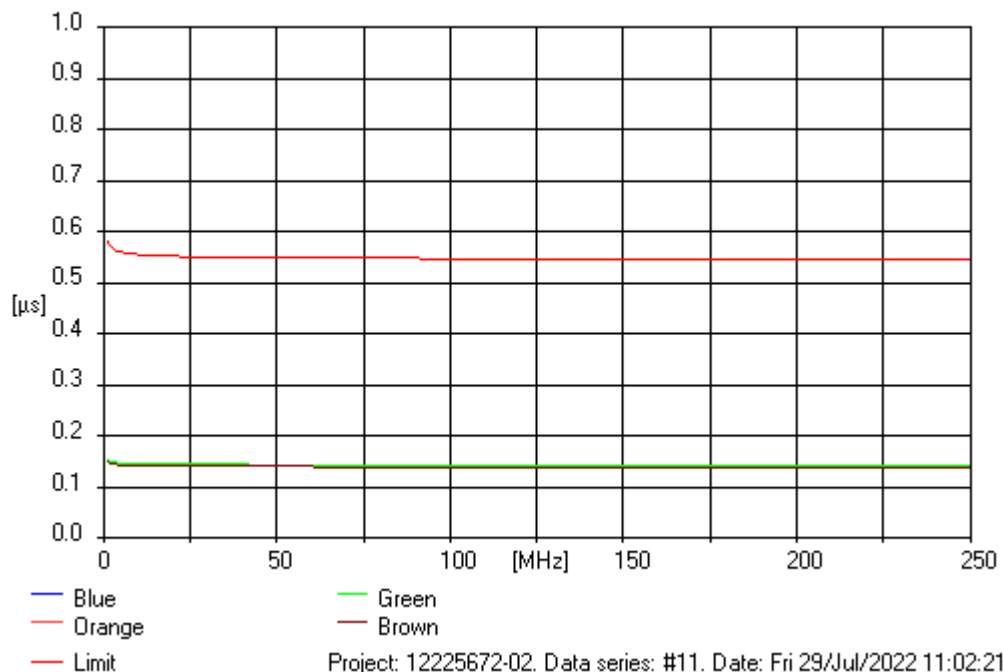

Table 35. Worst case margins at selected nominal frequencies.

Nominal Freq. [MHz]	Meas. Freq. [MHz]	Meas. value [ns]	Limit value [ns]	Calc. margin [ns]
1	1.0	153	580	427
4	4.1	148	562	414
16	15.9	145	553	408
100	100.0	144	548	404
250	250.0	143	546	403

**DELAY SKEW.**

Channel #2. Worst case margin: 46.4 ns.



Table 36. Worst case margins at selected nominal frequencies.

Nominal Freq. [MHz]	Meas. Freq. [MHz]	Meas. value [ns]	Limit value [ns]	Calc. margin [ns]
1	1.0	3.5	50.0	46.5
4	4.1	3.6	50.0	46.4
16	15.9	3.6	50.0	46.4
100	100.0	3.6	50.0	46.4
250	250.0	3.6	50.0	46.4

**Equipment:**

Network Analyser, Agilent E5071C, 4-port  
 Switch, Agilent, type 87050A  
 Balun, BH, type 040-0192  
 Balun, BH, type 040-0192  
 Balun, BH, type 040-0192

Instrument no.: 31187  
 Instrument no.: 80139  
 Instrument no.: 31301 to 31304  
 Instrument no.: 31305 to 31308  
 Instrument no.: 31185

#### 4.5 Resistance properties

Table 37. DC loop resistance, channel #1

Pair	Resistance [Ohm]	Requirement	Compliance
1	15.6	< 19	NO
2	15.4		NO
3	15.7		NO
4	15.3		NO

Table 38. DC resistance unbalance, channel #1

Pair	R unbalance [%]	Requirement	Compliance
1	0.3	< 2 %	NO
2	0.2		NO
3	0.1		NO
4	0.1		NO

**Equipment:**

Multimeter, Keithley, type 2000

Instrument no.: 31092

## 5 Reference to applicable standards and documents

Test of the cabling product is performed with reference to the following standards:

### 5.1 Generic cabling standards

ISO/IEC 11801-1:2017 (Ed. 1.0)

Information technology - Generic cabling for customer premises -  
Part 1: General requirements

ISO/IEC 11801-2:2017 (Ed. 1.0)

Information technology - Generic cabling for customer premises -  
Part 2: Office premises

CENELEC EN 50173-1:2018

Information Technology - Generic cabling systems - Part 1: General requirements

CENELEC EN 50173-2:2018

Information technology - Generic cabling systems - Part 2: Office spaces

TIA-568.2-D:2018

Balanced Twisted-Pair Telecommunications Cabling and Components Standard

### 5.2 Special requirements for EC VERIFIED

DQP231006 (version 29, May 2018)

Terms and conditions for the EC VERIFIED programme for Generic and Coaxial cabling

## 6 Test procedures

The tests carried out on the communication cabling under test are performed according to the standard: IEC 61935-1 Specification for the testing of balanced and coaxial information technology cabling - Part 1: Installed balanced cabling as specified in ISO/IEC 11801 and related standards.

The test methods are detailed in test procedures worked out by FORCE and approved by DANAK. In this section the procedures are described briefly.

### 6.1 Electrical test

The electrical tests on the communication channel under test are performed according to the procedures described in this section. The performed tests are shown in the following table. The floor cable is stretched on a non-conductive surface.

Table 39. Performed tests

	Measured from	
	Equipment end (patch panel)	Terminal end (wall outlet)
Attenuation	x	
Near end crosstalk (NEXT)	x	x
Attenuation to crosstalk, far (ACR-F)	x	
Return loss	x	x
Propagation delay	x	
Delay skew	x	
TCL	x	x
Resistance properties	x	



### 6.1.1 Attenuation (Att)

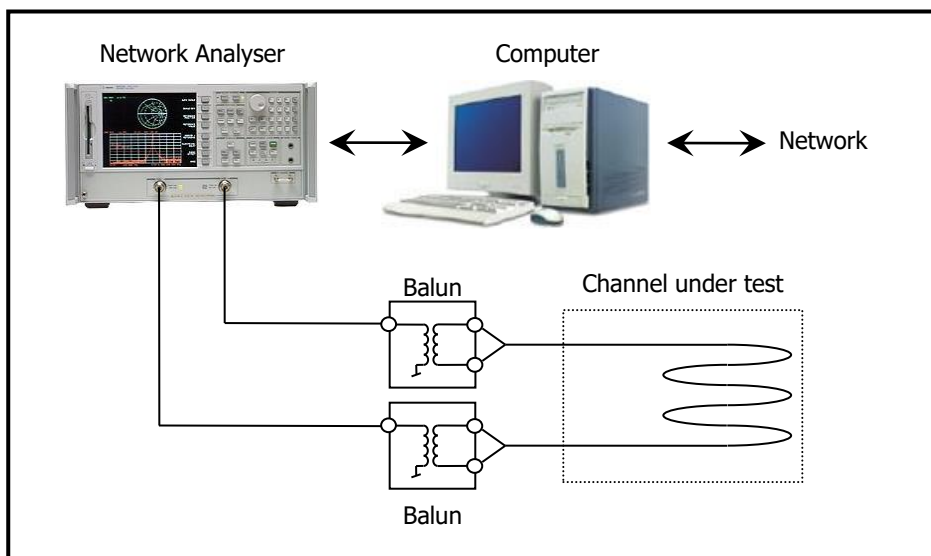

Figure 3. Test set-up for attenuation measurements.

Terminal end and equipment end are connected to one balun each.

The measurement uncertainty for Attenuation is dependent of the level of measured Attenuation. The uncertainty is shown in the table below:

Measured attenuation	Uncertainty
1 dB	±0.1 dB
10 dB	±0.3 dB
60 dB	±0.5 dB
80 dB	±2 dB

### 6.1.2 Return loss (RL)

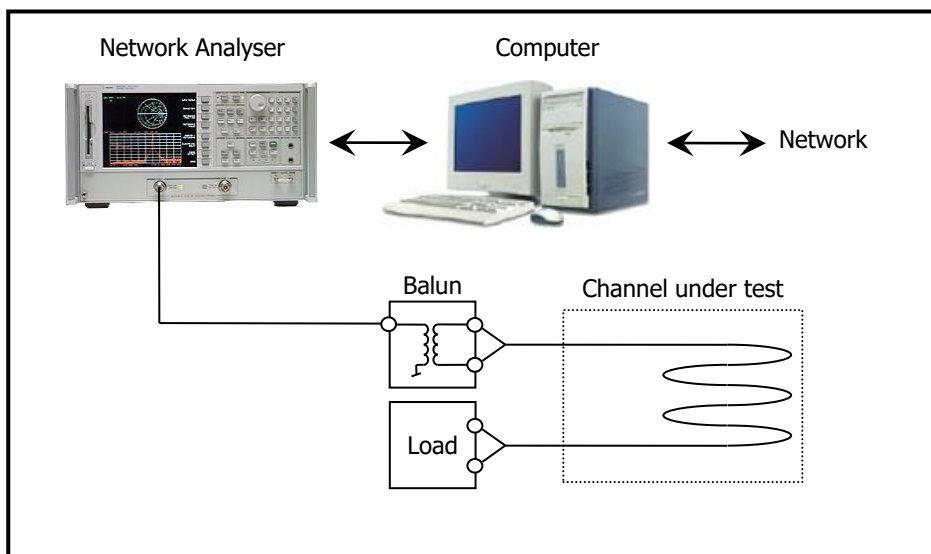

Figure 4. Test set-up for return loss measurements.

The return loss of the channel under test is measured with the far end terminated with a resistance of the specified characteristic impedance of the channel under test.

The measurement uncertainty for impedance is  $\pm 1.7\%$  at 100 MHz.

The measurement uncertainty for return loss is dependent of the measured return loss value. The error band is specified in the table below:

Measured return loss	Error band
5 dB	$\pm 0.2$ dB
10 dB	$\pm 0.3$ dB
15 dB	$\pm 0.5$ dB
20 dB	$\pm 1$ dB
25 dB	$\pm 2$ dB
30 dB	$\pm 3$ dB

At frequencies above 500 MHz add  $\pm 1$  dB to the uncertainty.

### 6.1.3 Near end crosstalk (NEXT)

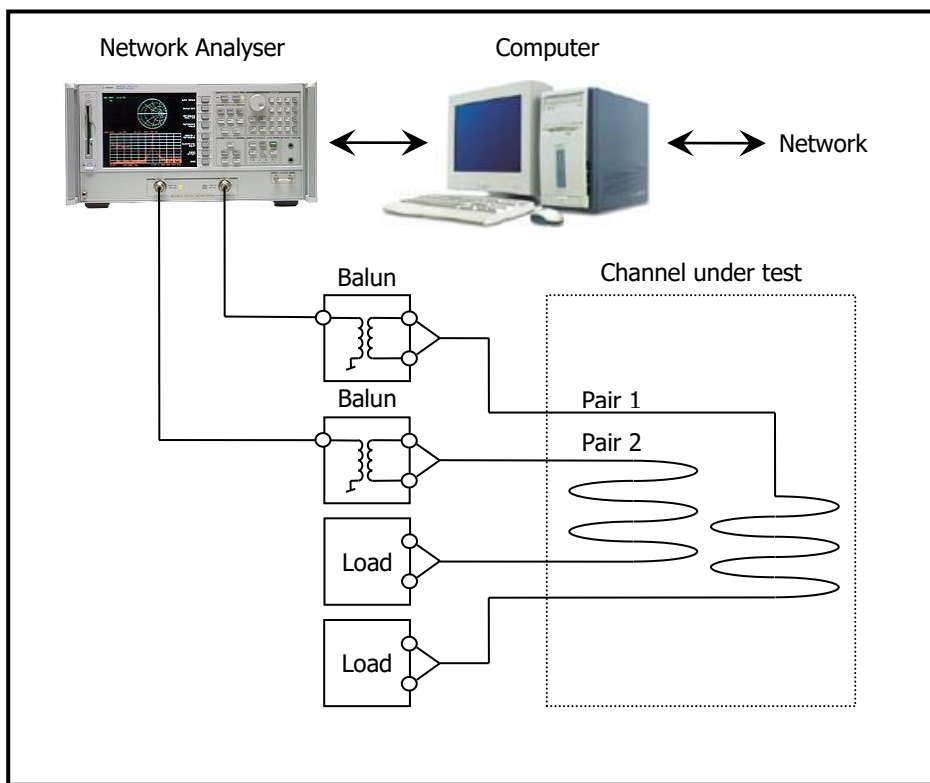

Figure 5. Test set-up for near end crosstalk measurements.

Near end crosstalk, NEXT, is measured as the attenuation from one pair to the others and these measurements are repeated for all pair combinations.

In the far end all pairs are terminated with a resistor with a value of the nominal characteristic impedance of the component under test.

The measurement uncertainty for NEXT is dependent of the level of measured NEXT. The uncertainty is shown in the table below:

Measured NEXT	Uncertainty
40 dB	±0.5 dB
60 dB	±0.6 dB
70 dB	±0.8 dB
80 dB	±1.7 dB

### 6.1.4 Powersum near end crosstalk (PSNEXT)

PSNEXT is calculated for each pair according to the formula:

$$PSNEXT = -10 \log(10^{-x1/10} + 10^{-x2/10} + 10^{-x3/10})$$

where x1, x2, x3 are the pair-to-pair crosstalk measurements in dB between the selected pair and the other three pairs.

The measurement uncertainty is the same as for NEXT measurements.

### 6.1.5 Attenuation to crosstalk loss ratio (ACR-N)

Attenuation to crosstalk ratio loss near end, ACR-N is calculated for each pair as the difference between the near end crosstalk loss and the attenuation.

The measurement uncertainty is the same as for NEXT measurements.

### 6.1.6 Power sum ACR (PSACR-N)

PSACR-N is calculated according to the formula:

$$PSACR - N = -10 \log (10^{-x1/10} + 10^{-x2/10} + 10^{-x3/10})$$

where x1, x2 and x3 are the ACR-N values in dB between the selected pair and the other three pairs.

The measurement uncertainty is the same as for NEXT measurements.

### 6.1.7 Attenuation to crosstalk ratio-far end (ACR-F)

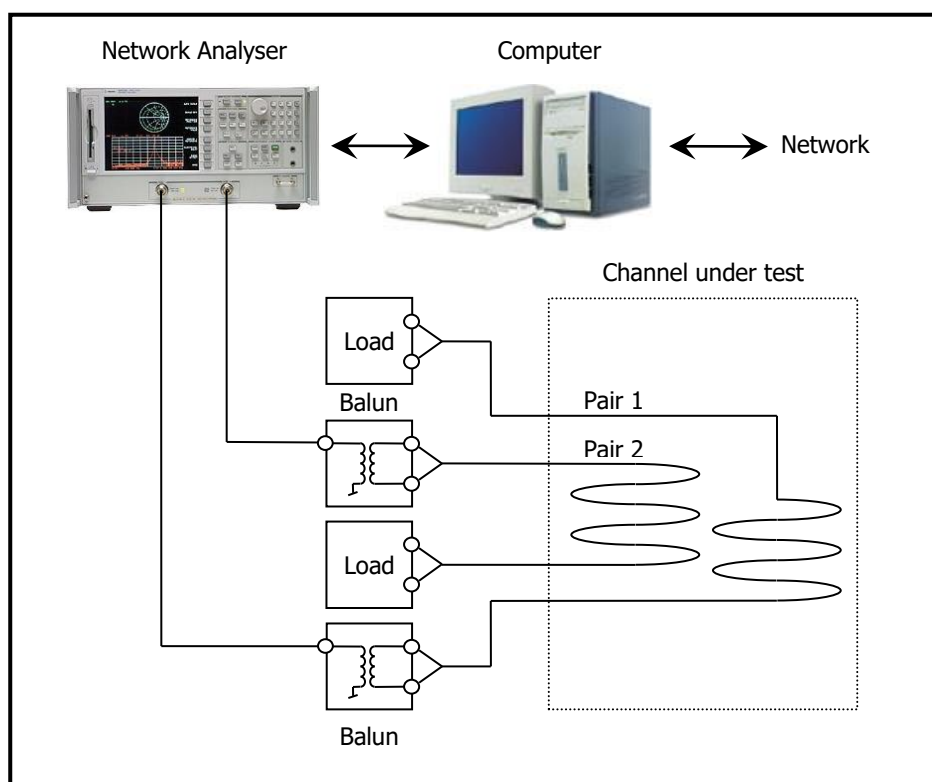

Figure 6. Test set-up for far end crosstalk measurements.

ACR-F is calculated from the measured values of far end cross talk, FEXT and attenuation, ATT.

$$ACR-F = FEXT - ATT$$

The measurement uncertainty for ACR-F is the sum of uncertainties for NEXT and ATT.

### 6.1.8 Power sum attenuation to crosstalk ratio far end (PSACR-F)

PSACR-F is calculated for each pair according to the equation:

$$PSACR - F = PSFEXT - ATTENUATION$$

$$PSFEXT = -10 \log (10^{-x1/10} + 10^{-x2/10} + 10^{-x3/10})$$

Where x1, x2, x3 are the pair-to-pair crosstalk measurements in dB between the selected pair and the other three pairs.

### 6.1.9 Unbalance attenuation, near end (Transverse conversion loss, TCL)

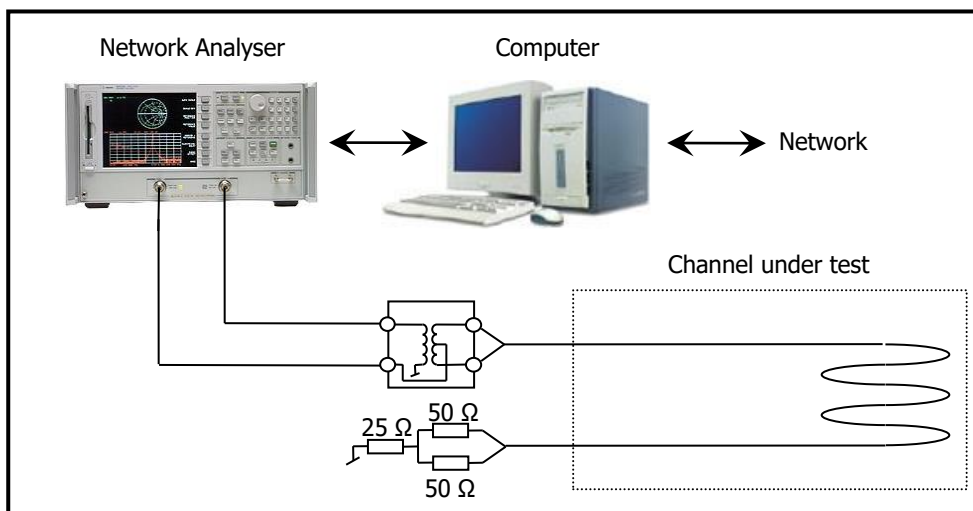

Figure 7. Test set-up for balance characteristics measurements.

Balance characteristics, transverse conversion loss, is measured as the signal attenuation between the common mode and the differential mode port of the test balun.

The test set-up is calibrated by imposing a known unbalance, consisting of a 50 Ohm resistor from one of the balance output terminals to ground. The instrument is adjusted for a reading of 16 dB for this unbalance. All pairs are terminated for differential and common mode signals during the test.

The measurement uncertainty for balance measurements is dependent of the level of balance. The uncertainty is shown in the table below:

Measured TCL	Uncertainty
20 dB	±0.3 dB
30 dB	±1 dB
40 dB	±3 dB

#### 6.1.10 DC loop resistance

DC loop resistance is measured for each conductor in a pair. The loop resistance is calculated by adding the resistance of each conductor. The measured value is corrected for the temperature of the test object in order to obtain the resistance at 20 °C.

The measurement uncertainty for DC resistance is ±1.4 %.

#### 6.1.11 Propagation delay

Propagation delay is measured by determining the phase delay of a signal transmitted through the cable.

$$\delta = \frac{\varphi}{2\pi \times f}$$

where  $\varphi$  is the phase delay,  $f$  is the frequency in Hertz.

The measurement uncertainty for delay is ±1 %.

#### 6.1.12 Delay skew

Delay skew is calculated as the difference between the maximum and minimum propagation delay over the four pairs at each frequency.

The measurement uncertainty for skew is ±10 %.



# APPENDIX

## Appendix 1 Test software

Test software according to information in the table below is used for the conducted tests.

Software name	Function	File name	Version	Date
Cablingtotal	Electrical cable HF tests	Cabltot	4.14	19.03.2021
ECCalculate	Calculated parameters	ECCalculate	12.00	15.11.2019
ECReport	Makes graphs	Xreport.exe	43.00	01.08.2014
Report 2002	Automatic report processing	Rapport.exe	2.4	25.11.2020
Report 2002 Database	Data and documents	Cable report	5.80	15.06.2021
Journal	Keeps journal data	Journal*.xlsm	5.00	01.06.2021
Worksheets	Keeps data	Work*.xlsm	7.0	17.12.2021